

भारतीय कृत्रिम अंग निर्माण निगम



(भारत सरकार का एक "मिनीरत्न" उपक्रम)
सामाजिक न्याय एवं अधिकारिता मंत्रालय के अधीन
एक आईएसओ 9001-2015 उपक्रम.
जी.टी. रोड नारामऊ, कानपुर-209217



www.alimco.in ई-मेल- mm_office@alimco.in, alimco_hq@vsnl.net
टेलीफैक्स : 0512-2770137, फोन : 2770174 टॉल फ्री नं. : 18001805129

ई-प्रोक्यूरमेंट खुली निविदा सूचना सं० एमएम/ओटी/37/ए एक्स

नीचे दिये गए विवरण के अनुसार निम्नलिखित मदों की आपूर्ति हेतु सुदृढ़ एवं प्रतिष्ठित निर्माताओं /आपूर्तिकर्ताओं से दो भागों (टेक्नीकल एवं प्राइस बिड) में ऑनलाइन निविदाएं आमंत्रित की जाती हैं:

क्र. सं.	निविदा सं०	मद	सामग्री का अनुमानित मूल्य (रु. लाख में)	ईएमडी हेतु डीडी की राशि टीसी बिड सहित (रु. लाख में)	निविदा खुलने की नियत तिथि (तकनीकी निविदा)
01	एमएम/ओटी/37/ए एक्स	बिहाइंड द इयर (बीटीई) श्रवण संबंधी उपकरण - डिजिटल कैटेगरी-II व III के लिये कॉम्पोनेंट्स से सम्बन्धित किट बैटरीज व इयर टिप्स के साथ।	2915.00	15.00	18.06.2019

इच्छुक निविदादाता एलिम्को की वेबसाइट www.alimco.in (केवल संदर्भ के लिए) व सीपीपीपी वेबसाइट <https://eprocure.gov.in/eprocure/app> से निविदा दस्तावेज डाउनलोड कर सकते हैं। निविदा शुल्क रु. 600/- डिमांड ड्राफ्ट एलिम्को के पक्ष देय, कानपुर के रूप में जमा कराना होगा। सभी एसएसआई/एमएसई विक्रेताओं को वैध पंजीकरण प्रमाण पत्र जमा करने पर निविदा शुल्क से छूट प्राप्त है।

निविदाकर्ताओं से अनुरोध है कि वे ऑन लाईन ई-टेंडरिंग प्रक्रिया के माध्यम से अपने प्रस्ताव/बिड <https://eprocure.gov.in/eprocure/app> पर जमा करें और निविदा शुल्क के विरुद्ध मूल डिमांड ड्राफ्ट एवं ईएमडी एलिम्को कार्यालय को जमा करने की निर्धारित तिथि को 1400 बजे तक भेजे जैसा कि संबंधित निविदा में उल्लेखित है, जो कि खुलने की निर्धारित तिथि को 1530 बजे खोला जाएगा जैसा ऊपर दिया गया है। एलिम्को को किसी भी या सभी आवेदनों/प्रस्ताव को बिना कारण बताये निरस्त करने का अधिकार है। वास्ते-एलिम्को, उप महाप्रबन्धक (सामग्री)

ARTIFICIAL LIMBS MANUFACTURING CORPORATION OF INDIA



(A Government of India Undertaking Miniratna Company)
(Under Ministry of Social Justice & Empowerment)
(An ISO 9001:2015 Company)
G.T. Road, Naramau, Kanpur-209217



www.alimco.in, Email: mm_office@alimco.in, alimco_hq@vsnl.net
Tele Fax : 0512-2770137, Ph. 2770174 Toll Free No. 18001805129

E-Procurement Open Tender Notice No. MM/OT/37/AX

Online Bids (Technical & Price Bid) are invited from well established & reputed Manufacturers/suppliers for supply of item as per details indicated below:

SI No.	Tender No.	Item	Approx. Estimated Value of Material (Rs. In Lakh)	Amount of DD to be enclosed alongwith TC Bid towards EMD (Rs. In Lakh)	Due Date of Opening of Tender (Technical -Bid)
01	MM/OT/37/AX	Kit Consisting of Components for Behind the Ear (BTE) Hearing Aid - Digital Category-II & III alongwith Batteries & Ear Tips	2915.00	15.00	18.06.2019

Interested Tenderers may download the tender document from ALIMCO website www.alimco.in (for reference only) and CPPP website: <https://eprocure.gov.in/eprocure/app>. Tender Fee of Rs. 600/- to be submitted in the form Demand Draft in favour of ALIMCO, payable at Kanpur. All SSI/MSE vendors are exempted from tender fee on submission of valid registration certificate.

Tenderers are requested to submit their Offers/Bids Online through E-Tendering Process only on <https://eprocure.gov.in/eprocure/app> and send the Original Demand Draft against Tender fee and EMD to reach ALIMCO office latest by 1400 hrs. before Bid submission end date which will be opened on Bid opening date at 1530 hrs. on the due date as indicated above. ALIMCO reserves the right to reject any or all requests / Offers without assigning any reason.

For ALIMCO - DGM (Materials)



ALIMCO

Artificial Limbs Manufacturing

Corporation of India

(A GOVERNMENT OF INDIA UNDERTAKING)

G.T. ROAD, KANPUR-U.P.

209217

E-TENDER NO. MM/OT/37/AX, DATE- 23.05.2019

BID SUBMISSION END DATE- 17.06.2019

TENDER DOCUMENTS

FOR

“Kit Consisting of Components for Behind the Ear (BTE) Hearing Aid –

Digital Category- II & III alongwith Batteries & Ear Tips”

Dear Sir,

1. Online tenders are invited for Item Code No. **TDOE160Z0 & TDOE170Z0** as per ALIMCO Specifications/ Drawing, against Purchase Orders to be placed on the successful Tenderer within specified period as per Purchase Order. Manual bids shall not be accepted.
2. Tender documents may be downloaded from [ALIMCO website www.alimco.in](http://www.alimco.in) (for reference only) and CPPP [website https://eprocure.gov.in/eprocure/app](https://eprocure.gov.in/eprocure/app). The tender schedules are mentioned below.

CRITICAL DATE SHEET

Published Date	23 May,2019 (1600 Hrs.)
Bid Document Download Start Date	23 May,2019 (1600 Hrs.)
Bid Submission Start Date	23 May,2019 (1600 Hrs.)
Bid Submission End Date	17 June,2019 (1400 Hrs.)
Bid Opening Date	18 June,2019 (1530 Hrs.)

Bids shall be submitted online only at CPPP [website: https://eprocure.gov.in/eprocure/app](https://eprocure.gov.in/eprocure/app). Tenderer/Contractors are advised to follow the instructions provided in the 'Instructions to the Contractors/Tenderer for the e-submission of the bids online through the Central Public Procurement Portal for e Procurement at <https://eprocure.gov.in/eprocure/app>.

INSTRUCTION FOR ONLINE BID SUBMISSION

The bidders are required to submit soft copies of their bids electronically on the Central Public Procurement (CPP) Portal i.e. <http://eprocure.gov.in/eprocure/app>, using valid Digital Signature Certificates. The instructions given below are meant to assist the bidders in registering on the CPP Portal, prepare their bids in accordance with the requirements and submitting their bids online on the CPP Portal.

REGISTRATION

- (i) Bidders are required to enroll on the e-Procurement module of the Central Public Procurement Portal by using the "Online Bidder Enrollment" option available on the home page. Enrolment on the CPP Portal is free of charge.
- (ii) During enrolment/ registration, the bidders should provide the correct/ true information including valid email-id & mobile no. All the correspondence shall be made directly with the contractors/ bidders through email-id provided.
- (iii) As part of the enrolment process, the bidders will be required to choose a unique username and assign a password for their accounts.
- (iii) For e-tendering possession of valid Digital Signature Certificate (Class II or Class III Certificates with signing key usage) is mandatory which can be obtained from SIFY /nCode/eMudra or any Certifying Authority recognized by CCA India on eToken/ Smartcard.
- (iv) Upon enrolment on CPP Portal for e-tendering, the bidders shall register their valid Digital Signature Certificate with their profile.
- (v) Only one valid DSC should be registered by a bidder. Bidders are responsible to ensure that they do not lend their DSCs to others which may lead to misuse and should ensure safety of the same.
- (vi) Bidders can than log into the site through the secured login by entering their user ID/ password and the password of the DSC/ eToken.

SEARCHING FOR TENDER DOCUMENTS

- (vii) There are various search options built in the CPP Portal to facilitate bidders to search active tenders by several parameters. These parameters could include Tender ID, organization name, location, date, value, etc. There is also an option of advanced search for tenders, wherein the bidders may combine a number of search parameters such as organization name, form of contract, location, date, other keywords, etc., to search for a tender published on the CPP Portal.
- (viii) Once the bidders have selected the tenders they are interested in, they may download the required documents / tender schedules. These tenders can be moved to the respective 'My Tenders' folder. This would enable the CPP Portal to intimate the bidders through SMS / e-mail in case there is any corrigendum issued to the tender document.
- (ix) The bidder should make a note of the unique Tender ID assigned to each tender, in case they want to obtain any clarification / help from the Helpdesk.

PREPARATION OF BIDS:

- (x) For preparation of bid Bidders shall search the tender from published tender list available on site and download the complete tender document and should take into account corrigendum if any published before submitting their bids.
- (xi) After selecting the tender document same shall be moved to the 'My favourite' folder of bidders account from where bidder can view all the details of the tender document.
- (xii) Bidder shall go through the tender document carefully to understand the documents required to be submitted as part of the bid. Bidders shall note the number of covers in which the bid documents have to be submitted, the number of documents – including the names and content of each of the document that need to be submitted. Any deviations from these may lead to rejection of the bid.
- (xiii) Any pre-bid clarifications if required, then same may be obtained online through the tender site, or through the contact details given in the tender document.
- (xiv) Bidders should get ready in advance the bid documents in the required format (PDF/xls/rar/dwf/jpg formats) to be submitted as indicated in the tender document/schedule. Bid documents may be scanned with 100 dpi with black and white option which helps in reducing size of the scanned document.
- (xv) Bidders can update well in advance, the documents such as experience certificates, annual report, PAN, EPF & other details etc., under "My Space/ Other Important Document" option, which can be submitted as per tender requirements. This will facilitate the bid submission process faster by reducing upload time of bids.

SUBMISSION OF BIDS:

- (xvi) Bidder should log into the site well in advance for bid submission so that he/ she upload the bid in time i.e. on or before the bid submission time. Bidder will be responsible for any delay due to other issues.
- (xvii) Bidder should prepare the Tender Fee and EMD as per the instructions specified in the NIT/ tender document. The details of the DD/BC/BG/ others physically sent, should tally with the details available in the scanned copy and the data entered during bid submission time. Otherwise the uploaded bid will be rejected.
- (xviii) While submitting the bids online, the bidder shall read the terms & conditions (of CPP portal) and accepts the same in order to proceed further to submit their bid.
- (xix) Bidders shall select the payment option as offline to pay the Tender Fee/ EMD and enter details of the DD/BC/BG/others.
- (xx) Bidder shall digitally sign and upload the required bid documents one by one as indicated in the tender document.
- (xxi) Bidders shall note that the very act of using DSC for downloading the tender document and uploading their offers is deemed to be a confirmation that they have read all sections and pages of the tender document without any exception and have understood the complete tender document and are clear about the requirements of the tender document.
- (xxii) Bid documents may be scanned with 100 dpi with black and white option which helps in reducing size of the scanned document. For the file size of less than 1 MB, the transaction uploading time will be very fast.
- (xxiii) If price quotes are required in XLS format, utmost care shall be taken for uploading Schedule of quantities & Prices and any change/ modification of the price schedule shall render it unfit for bidding.
Bidders shall download the Schedule of Quantities & Prices i.e. [Schedule-A, in XLS format and save it without changing the name of the file](#). Bidder shall quote their rate in figures in the appropriate cells, thereafter save and upload the file in financial bid cover (Price bid) only.

If the template of Schedule of Quantities & Prices file is found to be modified/corrupted in the eventuality by the bidder, the bid will be rejected and further dealt as per provision of clause no 23.0 of ITB including forfeiture of EMD. The bidders are cautioned that uploading of financial bid elsewhere i.e. other than in cover 2 will result in rejection of the tender.

- (xxiv) Bidders shall submit their bids through online e-tendering system to the Tender Inviting Authority (TIA) well before the bid submission end date & time (as per Server System Clock). The TIA will not be held responsible for any sort of delay or the difficulties faced during the submission of bids online by the bidders at the eleventh hour.
- (xxv) After the bid submission (i.e. after Clicking “Freeze Bid Submission” in the portal), the bidders shall take print out of system generated acknowledgement number, and keep it as a record of evidence for online submission of bid, which will also act as an entry pass to participate in the bid opening.
- (xxvi) Bidders should follow the server time being displayed on bidder’s dashboard at the top of the tender site, which shall be considered valid for all actions of requesting, bid submission, bid opening etc., in the e-tender system.
- (xxvii) All the documents being submitted by the bidders would be encrypted using PKI (Public Key Infrastructure) encryption techniques to ensure the secrecy of the data. The data entered cannot be viewed by unauthorized persons until the time of bid opening. The confidentiality of the bids is maintained using the secured Socket Layer 128-bit encryption technology.

ASSISTANCE TO BIDDERS:

- (i) Any queries relating to the tender document and the terms and conditions contained therein should be addressed to the Tender Inviting Authority for a tender or the relevant contract person indicated in the tender. The contact number for the helpdesk is 011-29571526 between 10:30 hrs. to 17:00 hrs.
- (ii) Any queries relating to the process of online bid submission or queries relating to CPP Portal in general may be directed to the directed to the 24X7 CPP Portal Helpdesk. The 24X7 Help Desk Number 0120-4200462, 0120-4004002 and +91-8826246593. The helpdesk e-Mail id is support-eproc@nic.in.
- (iii) If any query is not resolved by the CPP Portal Helpdesk, you may contact the Nodal Officer (procurement), AIMCO at +91-9766681016.

Toll Free Number 1800-3070-2232. Mobile Nos. 91-7878007972 and 91-7878007973.

भारतीय कृत्रिम अंग निर्माण निगम
ARTIFICIAL LIMBS MANUFACTURING CORPORATION OF INDIA
(भारत सरकार का उपक्रम)



(A GOVERNMENT OF INDIA UNDERTAKING)
सामाजिक न्याय एवं अधिकारिता मंत्रालय के अधीन
UNDER MINISTRY OF SOCIAL JUSTICE & EMPOWERMENT
आई एस ओ 9001:2008 प्रतिष्ठान
AN ISO 9001 : 2008 COMPANY
जी० टी० रोड, कानपुर-209217
G. T. ROAD, KANPUR – 209217
टोल फ्री नं०/Tol Free No. 18001805129



वेबसाइट / Website: www.alimco.in
ईमेल / Email : mm_office@alimco.in

फैक्स / FAX : 0512-2770137
दूरभाष / Phone : 0512- 2770174
GSTINNO.-09AABCA8899F1Z6
CIN No. : U85110UP1972GOI003646

Ref. No. : MM/OT/37/AX

REF: - E-TENDER NO. MM/OT/37/AX
Due Date for Opening: 18.06.2019

Dear Sir,

1. Online e-tenders are invited for two bid system i.e. Technical Bid (TC-Bid) & Price Bid (P-Bid) for the supply of **Kit Consisting of Components for Behind the Ear (BTE) Hearing Aid – Digital Category- II & III alongwith Batteries & Ear Tips** as per ALIMCO Drawings / specifications against our Purchase Orders to be placed on the successful Tenderer / Tenderers within a period of Twelve months from the date of finalization of 1st Purchase Order, extendable for a further duration for 01 year by mutual consent. Manual bids shall not be accepted/entertained/processed further.

2. The tentative quantities likely to be covered by Purchase Orders are indicated at **ANNEXURE 'A'**. The material would be required to be supplied on staggered delivery schedule to its H.Q. at Kanpur or to its Auxiliary Production Centers (AAPCs) at Jabalpur, Bangalore, Bhubaneswar & Ujjain, as the case may be. The total requirement of above material may vary substantially from the quantity indicated in ANNEXURE-'A'. The tentative monthly requirement will be Fourteen thousand Kits every month (TD O E 16 0Z0 – 3000 Kits per month & TD O E 17 0Z0 – 11000 Kits per month) but the Corporation reserves the right to seek delivery/Supply Kits more than that of indicated above every month.

The Corporation has right to place Order for an additional quantity equal to 100% of the original Order with the successful bidders at same rates, terms & conditions within a period of 06 months from the date of last supply or during the currency of the Order.

3. Offer of supply will have to be made as per the following terms and conditions:-

A. SUBMISSION OF E-TENDER

- A-1.** The detailed tender documents may be downloaded from <http://eprocure.gov.in/eprocure/app> till the last date of submission of e-tender. The Tender must be submitted online through CPP Portal. Tender shall be submitted online in Techno-Commercial Bid ‘TC’ BID for which the formats are also enclosed at Annexure-I and Price Bid ‘P’ BID for which the formats are also enclosed at **Annexure II** Format for submission of Samples, if required, are enclosed at **Annexure III**.

Pre Qualification/Mandatory criteria/ Parameters:-

- A-2.** Procedure for submission of tender documents shall be as under :-

- a)** Part I (TC- BID) Signed and Scanned copy of the Technical bid documents as under must be submitted Online on CPP Portal: <http://eprocure.gov.in/eprocure/app> (List of all requisite Documents to be scanned and uploaded (Under Cover 1) within the specified period of bid submission) , However, Only DD towards tender fee, EMD & sample must be physically submitted on the given address in office of “Dy. General Manager (Materials), ALIMCO, G.T. Road, Kanpur-209217 (U.P.)” which must be received on or before bid Submission End date and time as specified in the tender & Scanned copies of the same must be Uploaded online in Cover 1.

- i)** **The interested tenderers must submit DD/Pay Order for 600/- towards cost of Tender documents if down-loaded from the website of the Corporation/Central E-procurement Portal (All SSI/MSE Vendor are exempted from Tender Cost on producing/submitting Valid Udyog Aadhaar Memorandum only) as mentioned.**
- ii)** **EMD by way of Demand Draft or Banker’s Cheque. SSI/MSE Units having valid registration with Udyog Aadhaar Memorandum (UAM) for category of items as against this tender will be exempted from payment of EMD. Such SSI/MSE Tenderers are required to enclose/upload (under cover 1) a certified copy of valid registration certificate of Udyog Aadhaar Memorandum which is mandatory to avail the exemption clearly showing the category of item. If the Registration is for the category of Item other than what has been Tendered by the Corporation, the exemption from EMD will not be allowed/admissible and tenderer needs to submit full amount of EMD as per tender alongwith their TC-Bid only to avoid summarily rejection of their offer.**

The tenderer claiming EMD exemption based on Udyog Aadhaar Memorandum (UAM) certificate are required to submit an undertaking (please refer Annexure –B-7) alongwith their quote/offer that the items quoted/offered are only for registered items/category of items as have been mentioned in the valid Udyog Aadhaar Memorandum (UAM) certificate and submitting quote contrary (full or part) to the undertaking will cause summarily rejection of their quote/offer.

- iii)** Scan Copy of Income Tax return for the previous financial year 2017-18 i.e. Assessment Year 2018-19, duly signed & stamped.
- iv)** Scanned Copy of GST Registration Certificate, if applicable, duly signed & stamped, clearly mentioning the GSTIN number.

- v) The sample (free of Cost & non returnable) of Kit consisting of components for BTE comprise of following assemblies alongwith batteries & Ear Tips will be submitted by the tenderer as indicated in Annexure 'A' in a separate sealed cover and kept inside the TC-Bid envelope or alongwith as the case may be alongwith Annexure III:-
- a) Amplifier Assembly
 - b) Receiver Assembly
 - c) Microphone Assembly
 - d) Housing Pair Assembly
- Kindly note that only Kit consisting of above Assemblies of BTE alongwith Batteries & Ear Tips would be accepted as samples and in no case Assembled BTE will be accepted by the Corporation. The Samples of Kit consisting of Components for BTE Hearing Aid Digital alongwith Batteries and Ear Tips submitted by the tenderer would be the property of ALIMCO and will not be returned in any circumstances and no claim in this respect shall be entertained.
- vi) Specific Confirmation in the format enclosed at Annexure 'B1' to the effect that the material quoted/to be supplied is/will be as per ALIMCO Specifications & drawing alongwith requisite Test Certificate **Format to the effect is enclosed at Annexure 'B-1'**.
- vii) The tenderer has to submit an undertaking to supply the additional quantity of material equal to 100% of the Order quantity at the same rates and terms & conditions if Ordered within a period of 06 months from the date of last supply or during the validity of Order **in the format enclosed at Annexure 'B-2'**.
- viii) The tenderer should have an average annual turnover of not less than **Rs. 583.00 Lakh in the relevant field** during the last 03 financial years i.e. 2016-17, 2017-18 & 2018-19. In order to authenticate, **a certificate regarding average turnover during the above last three financial years from a qualified Chartered Accountant is required to be furnished alongwith 'TC-Bid'**.
- ix) The tenderer should submit an undertaking that his/her firm has not been debarred/terminated/blacklisted/put on holiday to participate in the tender by any Govt. Institution, PSUs, State Govt. or Central Govt. Deptt. **in the format enclosed at Annexure-B-3**.
- x) The tenderer should submit an undertaking that his/her Offer is valid for acceptance for 90 days from the date of opening of TC- Bids **in the format enclosed at Annexure-B-4**.
- xi) The Tenderer should submit an undertaking that the payment terms regarding payment of basic amount within 30 days after supply & acceptance/approval of material or submission of bill whichever is later and subsequent payment of GST as specified **in the format enclosed at Annexure-B-5** is acceptable to them.
- xii) The Tenderer has to undertake a replacement warranty of 24 months of material supplied from the date of receipt of store in ALIMCO. A Confirmation regarding above Warranty for materials offered need to be furnished, as per Annexure –A **in the format enclosed at Annexure –B-6**.
- xiii) The tenderer should submit an undertaking that the items quoted/offered are only for registered items/ category of items as have been mentioned in the valid **Udyog Aadhar Memorandum (UAM) certificate in the format enclosed at Annexure B-7**. (To be submitted only by SSI/MSE Units having valid Registration certificate of **Udyog Aadhar Memorandum (UAM)** Claiming Tender Fee & EMD exemption.).

- xiv) Technical Compatibility chart regarding specifications of material offered by you vis-a-vis required specifications as per Annexure 'C-1' & 'C-2'.
- xv) The tenderers have to submit a list of Institutions/Buyers to whom supplies of a minimum **48,000 Kits** of components of BTE/Hearing devices has been made in the last 3 years i.e. FY 2016-17, 2017-18 & 2018-19. Documentary evidences, the copies of Purchase Orders and proof of successful execution of Order issue by customer in support of experience in the field. (Copy of such supply orders needs to be enclosed duly signed & stamped)
- xvi) The Tenderer shall have past working experience in the similar field i.e. supply of BTE Kits in last 03 years i.e. FY 2016-17, 2017-18 & 2018-19. The documentary evidence such as copy of purchase order, proof of successful execution of order issued by customer, etc. pertaining to all the three years have to be provided alongwith tender TC Bid (Copy of such supply Orders needs to be enclosed duly signed & stamped)

(All these documents / details / confirmation should necessarily be submitted specifically & in the same order as mentioned above.)

NOTE:

Only DD towards tender fee, EMD & sample (if applicable) must physically be submitted on the given address to office of "Dy. General Manager (Materials), ALIMCO, G.T. Road, Kanpur-209217 (U.P.)" ALIMCO, Kanpur which must be received on or before Bid Submission End date and time as specified in the tender & Scanned copies of the same must Uploaded online in cover 1.

(ii) Vendors shall be allowed to submit the sample only once alongwith the Tender. However, Corporation in its sole discretion may request tenderers to submit fresh sample in case of rejection of the sample submitted by the tenderer alongwith their TC-Bid, within 07 working days of communication by the Corporation alongwith reason of rejection thru e-mail failing which the option to submit second sample will stand lapsed. In case, the second sample also gets rejected/fails, no further opportunity will be given to the tenderer to submit the sample.

Just as in case of Tender Sample, only two opportunities shall be allowed for submission of advance sample before the supplies against the purchase order to the successful bidder.

iii) Similarly, the Corporation in its sole discretion may seek clarifications/required documents, if any from the bidders, if considered necessary only once. The same will be required to be submitted by bidders within 07 working days beyond this period this opportunity will stand lapsed & no further opportunity will be provided.

iv) **The Corporation in its sole discretion has right to depute a Technical Committee at TC-Bid/Technical evaluation stage to visit the work place/Factory of the tenderer/tenderers to ascertain the capability/capacity of the tenderer/tenderers, if felt necessary by the Corporation. The recommendation of the Technical Committee regarding acceptance/non-acceptance of the offer/offers shall be binding on the tenderers. No representation against the recommendation/decision of the Technical Committee/Corporation shall be admissible/entertained.**

v) **The testing/evaluation of samples shall be done with the testing facilities available in the corporation by/through the available manpower of the Corporation. The test/evaluation of samples by the Corporation shall be final and binding on the tenderers and no correspondence/representation in this respect shall be admissible/entertained.**

vi) Price bids of only those tenderers, who are assessed as technically qualified by the Corporation shall be opened.

vii) **Submission of Offer against this tender shall be construed as unconditional acceptance of all terms & conditions laid down in this tender.**

(B) Part II (Financial / Price Bid)

i) The currency of all quoted rates shall be Indian Rupees. All payment shall be made in Indian Rupees.

ii) In preparing the financial bids, bidders are expected to take into account the requirements and conditions laid down in this Tender document. The financial bids should be uploaded online as per the specified “.xls” format & details given in Annexure-II. (Excel sheet attached as ‘.xls’ with the tender. It should include all costs associated with the Terms of Reference/Scope of Work of the assignment).

iii) Specifically, the offer must be quoted with complete breakup **i.e. Basic Price, packing forwarding, freight, applicable GST along with HSN Code/Tax. In case no % in Freight & Packing Forwarding mentioned, Basic rate quoted shall be deemed to be inclusive of Freight and P & F charges.**

iv) The Financial bid should be according to the. Xls format given in the Tender Document. It should be ensured that no required value against an item is missed. If the bidder does not want to charge for an item, the value must be filled as “0” (ZERO).

v) **The Price Bid shall contain price for supply upto ALIMCO, HQ, Kanpur or to its Auxiliary Production Centers (AAPCs) at Jabalpur, Bangalore, Bhubaneshwar & Ujjain, as the case may be mentioning complete breakup i.e. Basic Price, packing forwarding, freight, applicable GST along with HSN Code/Tax as per the format at Annexure –II.(If zero ‘0’ is quoted in Packing & forwarding and freight; Basic Price would be deemed to be including freight and packing & forwarding.)**

vi) Please note that no indication with regard to the rates / amounts in any of the documents submitted along with ‘TC’ BID is required to be given /mentioned.

vii) The Tender should be uploaded/submitted on line well within specified time & date and the requisite hard copies of Tender Fee, EMD, Samples, if applicable (as per Annexure-A) should be dispatched/submitted physically well in time so that the same should reach on or before Bid Submission End Date. The Tenderers may in their own interest, send their hard copies, samples etc, by Registered / Speed Post (Acknowledgement due), but postal and transit delays may not be considered for reckoning the tenders as ‘VALID’ for our consideration.

viii) ALIMCO reserve the right to open Price Bid of successful Techno Commercial Bidders only and also reserve the right to split up total order quantity among two/three bidders and at its discretion. In case of split up of quantities upto two bidders, 60% quantity will be placed on L1 and 40% quantity on L2 provided L2 agrees to match rates with L1. In case of split of quantity upto 3 parties, 60% of the quantity may be placed on L1 and 20% each on L2&L3 provided they agree to match L1 rates. In case L2 and L3 refuse to match L1 rates, the entire quantity of supplies will be ordered to L1 party. Moreover, in case one of the parties i.e. L2 and L3 refuses to match L1 rate, the supplies will be divided in 60:40 ratio among L1 and L2/L3 parties as the case may be.

(ix) L1 tenderer is the party whose nett rates inclusive of Basic rate, Packing & forwarding & freight, excluding applicable GST rate/amount, work out to be lowest against the tender.(L-1 Tenderer whose rates i.e. net cost to company after taking in to account the input tax credit works out to be the lowest).

(x) **Submission of Tender:** - Online tenders complete in all respects, must be submitted /uploaded on line on or before the last date and time as specified in the schedule of events. The ALIMCO may, at its own discretion, alter/extend the last date for submission of tenders. Tenderers are required to send their original DD of tender fee, EMD and sample along with relevant document addressed to Dy. General Manager (Materials Management), ALIMCO, G.T. Road, Kanpur-209217.

A-3. SUBMISSION OF EMD:- All the Tenderers must submit EMD of Rs. **15.00 Lakhs** separately alongwith cost of Tender Documents if downloaded from website by Demand Draft in favour of ALIMCO, KANPUR (DD preferably of State Bank of India, payable at State Bank of India, ALIMCO BRANCH, KANPUR, Branch Code No.03962) or Pay Order or Banker's Cheque as an Earnest Money Deposit. **No other mode is acceptable.** The EMD shall be released within 30 days of finalization of the Purchase Orders to the unsuccessful Tenderers. No interest will be payable on the EMD.

A-4 Tenders without cost of Tender Documents/ EMD / inadequate EMD are liable to be rejected irrespective of rates quoted.

A-5 All SSI/Micro & Small Enterprises (MSE) may download Tender Documents free of Cost & are exempted from Tender Cost on submission of valid registration certificate through on line (e-procurement portal). However, SSI/MSE Units having valid **Udyog Aadhar Memorandum (UAM)** for the Category of items/ nature of business/ type of service as against this tender, will only be exempted from payment of EMD. A certified copy of the valid registration of **Udyog Aadhar Memorandum (UAM)** shall be furnished by the Tenderer through on line (e-procurement portal). If the registration is for the category of Item other than what has been Tendered by the Corporation, the exemption from EMD will not be allowed/admissible and tenderer needs to submit full amount of EMD as per tender along with their TC-Bid only to avoid summarily rejection of their offer. [Please refer Clause No. 3A, A-2(a)(ii)].

A-6 The earnest money will be forfeited if the tenderer withdraws his tender before the period of validity (i.e. minimum 90 days) and / or tenderer fails to furnish requisite security deposit within the specified period after the award of Order / Contract.

A-7. Subsequent to placement of Purchase Order, the successful tenderer will be required to deposit a sum equal to 5% of the ordered value subject to a maximum of Rs. 50.00 lakh as Security Deposit in the form of Demand Draft or Pay Order or Bankers Cheque or irrevocable Bank Guarantee from a Nationalized Bank in the format to be made available by ALIMCO only in favour of ALIMCO payable at Kanpur for due discharge of the Purchase Order released on the basis of this tender. This will be retained till the expiry of warranty Period for the material supplied & may be refunded on compliance as per para A-10. No interest will be payable on the Security Deposit. Security Deposit is required to be given on placement of Order before the start of the supplies. **Corporation, on specific request by the tenderer, may relax the condition of depositing of Security Deposit & deduct the Security Deposit amount @ 25% from the Running Bill of the tenderer in place of Security Deposit as applicable. However, to relax the condition, as per purchase policy, will be prerogative of the Corporation.** The earnest money already submitted with the tender may be adjusted towards Security Deposit. The successful vendor may also give their consent/request for retaining/converting their EMD into part of Security deposit & deposit the balance amount towards SD.

A-8. The Corporation reserves the right to forfeit the EMD if the Tenderer withdraws his Tender before the period of validity of the Tender (i.e. minimum 90 days) or alters the condition(s) of the offer on his own after closing date & time for receipt of Tender, but before the original validity of the Offer and/or fails to furnish requisite PG/Security deposit within specified period after award of Contract, wherever applicable.

A-9. Security Deposit shall be furnished within 15 days If the SD is in the form of Bank Guarantee, the validity of bank guarantee shall be for two more months beyond date of last supply. Non submission of Security amount within the time specified for the purpose shall amount to the breach of an essential conditions of the Contract and shall render the Contract liable to cancellation & the contractor shall be liable for all consequence thereof or caused there by.

A-10. The Security deposit may be refunded/returned on submission of irrevocable, unconditional & acceptable Bank guarantee as performance guarantee equivalent to 5% of the ordered value subject to a maximum of Rs.50.00 lakhs by the party to cover its obligations to offer free of cost replacement under the warranty period from any nationalized bank. The text of the bank guarantee will be provided by the Corporation.

A-11. The warranty as applicable/required to be offered for the items covered under this Tender is indicated in Annexure-A.

A-12. Refund of Bid Security (EMD) & Security Deposit:- EMD will be refunded to unsuccessful bidders within 30 days of finalization of Purchase Order/Work/Service Contract. In case of successful bidders EMD/Security Deposit will be refunded within 30 days after completion of the Purchase Order/Work/Service Contract and on receipt of the performance guarantee to cover the discharge of contractual obligations under the warranty period/defect Liability/period as applicable.

In case the Supplier/Contractor is awarded PO/Work/Service Contract for few items and they have deposited the EMD/Security Deposit for all tendered items, the EMD/Security Deposit will be refunded after retention of EMD/Security Deposit (@ 5% of Order value subject to Maximum Rs.50.00 Lakhs) as per Conditions indicated as para A3 & A7.

A-13 The tenderers may submit their bid online through CPP Portal [http:// eprocure.gov.in / eprocure/app](http://eprocure.gov.in/eprocure/app). However, original DD of EMD & tender fee (**tender reference number on the back of the Bank Draft**) along with sample, if specified in the tender should be send by Registered / Speed post Acknowledgement so as to reach the same on or before the Bid submission end date & time addressed to **Dy. General Manager (Materials), ALIMCO, G.T. Road, Kanpur-209217 (U.P.)**. but postal and transit delay may not be condoned in reckoning the tenders for our consideration.

A-14 The Earnest Money will not be adjusted against any pending bills or with balance payment, if any.

A-15. Tenderers must also indicate the following particulars on the face of the envelope containing requisite DD /relevant document & sample

a) Name & Address of the Tenderer

b) Tender No.MM/OT/37/AX for the supply of **Kit Consisting of Components for Behind the Ear (BTE) Hearing Aid – Digital Category- II & III alongwith Batteries & Ear Tips Due on: 18.06.2019 (In case, the last date of submission/opening of tender is declared holiday/closed, the same shall be extended to the next working day automatically without any change of timing for submission/opening of tender.)**

OPENING OF E-TENDER

Due Date of Opening of E-Tender: 18.06.2019

B-1. All the tenderers must submit their tender on line using CPP portal [http :// eprocure.gov.in /eprocure/app](http://eprocure.gov.in/eprocure/app) by on or before date & time as per Critical Data Sheet. If the due date happens to be a holiday the same stands extended to the date of next working day with time remaining the same. However, the Corporation has the right to alter the date & time of Tender closing & opening. The same shall be notified only on the website of the Corporation.

- B-2** Late Tenders i.e. the original DD of EMD tender fee (**tender reference number on the back of the Bank Draft**) & sample, if specified in tender, not received before due time & date will not be considered. Tenders from black listed/debarred parties will also not be considered.
- B-3** **Rectification of arithmetical errors:-** While scrutinizing the Tenders if a difference is detected between the unit price and the total price the former will prevail. In case of discrepancy between the figures and words, the latter would prevail. The arithmetical errors mentioned above shall not be the cause of rejection of a Tender.
- B-4** If a Tender does not substantially confirm to the specifications or contains inadmissible reservations or exception to the Tender documents or does not otherwise substantially respond to the Tender documents and or have conditional offers it should be rejected.
- B-5** Only the 'TC'BID (Cover 1) of the tender will be opened (online) on date of opening at 1530 Hrs. On **18.06.2019** (Refer Critical Data Sheet) by the Tender Opening Committee of ALIMCO in presence of representatives of tenderes. who may like to be present (online) and the following procedure will be followed:-
- i) The Tender Opening Committee of ALIMCO shall open (online) cover 1 i.e. 'TC'BID part of all tenders Tender Opening Committee in presence of tenderers. (if present on line during opening of tenders) The Evaluation Committee shall go into details of technical bids parameters (TC-BID & Sample, if applicable, and Price Bid of only those Tenderers shall be opened whose TC Bid & sample (if applicable) are found / assessed to be acceptable at the sole discretion of the Corporation.
- ii) The Corporation in its sole discretion has the right to seek further clarifications/documents from the tenderers relating to 'TC-Bids' of the tenderers, if such information is essential.
- iii) In case, if any tenderer submits only 'TC-Bid' or 'P-Bid' against the tender, the same shall be treated as incomplete and Offer will be summarily rejected.

C. VALIDITY OF TENDER

C-1. The offers shall remain open for acceptance for a minimum period of 90 days extendable by mutual consent from the date of opening of tender. Any tender having validity of less than 90 days will not be considered and the Offer shall be summarily rejected.

C-2. If notified within this period that the tender has been accepted, the tenderer shall be bound by the terms of the offer along with the terms that have been agreed to mutually.

C-3. All tenders without PROPER SPECIFICATION / MAKE / BRAND AND TEST CERTIFICATES, wherever required, are liable to be rejected. Tenderers must submit samples in sealed envelope alongwith their Offer (TC-Bid) as applicable. The successful Tenderer/Tenderers shall also be required to submit requisite Test certificate alongwith the supplies if required as per Annexure –‘A’.

C-4 The Corporation would provide the necessary GST Tax Forms to facilitate dispatch /sale of material directly to the Corporation. **Tenderers should indicate their GST registration number & respective HSN code/s of items without fail.**

C-5. In case tenderers happen to be a dealer / distributor for any reputed Brand, a copy of authorization certificate to this effect duly certified from the principal for validity should invariably be provided.

D.**DETAILS OF OFFER**

D-1. (i) Rate should be quoted in Rupee per unit in figures and in words. In case of any difference, the figures given in words will only be considered and binding. Rate should be quoted alongwith Packing & Forwarding, Freight charges with applicable GST etc, for DELIVERY at premises of ALIMCO, Kanpur or to its Auxiliary Production Centers (AAPCs) at Jabalpur, Bengaluru, Bhubaneshwar & Ujjain as the case may be. The offers other than “FOR ALIMCO Kanpur or FOR AAPC Jabalpur or FOR AAPC Bengaluru” delivery will summarily be rejected.

The following data shall invariably be furnished:-

- (a) Basic Price in ₹.
 - (b) Packing & Forwarding Charges, if any, in % & ₹.
 - (c) Freight Charges in % & ₹.
 - (d) Good & Service Tax (GST) along with HSN code, if any, applicable in % and ₹.
- ii) **Offers for supplies other than FOR Free delivery / Ex-shop / Ex-works, Kanpur in case of H.Q. ALIMCO & the relevant district in case of AAPCs or FOR Kanpur in case of H.Q. ALIMCO & FOR the relevant district in case of AAPCs will be summarily rejected.**
- iii) **If nothing is mentioned, the prices will be deemed to be FOR free delivery at ALIMCO, Kanpur or to its Auxiliary Production Centers at Jabalpur, Bangalore, Bhubaneshwar & Ujjain, of the Corporation, as the case may be.**

D-2. All entries in the offers shall be either typed or neatly hand written. Tender having over writings / fluid application / cutting etc. without proper authentication will be rejected.

D-3. No Toolings / Die development charges are payable by the Corporation in case the same is required to be developed for making the supplies / samples.

E.**T A X E S**

E-1. The Good & Service Tax(GST) applicable, the rate should be given clearly and separately with their HSN Codes. **The offer quoted inclusive of GST Taxes (if applicable), Packing & Forwarding charges and freight charges will summarily be rejected.**

E-2. ALIMCO Good & Service Tax (GST) Registration details are given below.

**AAPC, Ujjain AAPC, Bhubneswar AAPC, Jabalpur AAPC, Bengaluru H.Q, Kanpur
GSTIN No 23AABCA8899F1ZG 21AABC88999F1ZK 23AABCA8899F1ZG 29AABCA88999F1ZA 09AABCA8899F1Z6**

E-3. Variation Clause:- Any change (Increase / Decrease) in Govt. Duties / Levies / GST as amended made applicable by Govt.(State / Central) from time to time at the rate as will be applicable over & above the basic price/rate quoted by parties in their offer during the currency of Purchase Order/Contract shall be considered by the Corporation for amendment on party's request alongwith necessary documents in support of their claim/amendment.

E-4. The tenderers are required to quote with correct rate of GST taxes along with HSN code for quoted items etc. as applicable. P.O. shall be placed as per quotation. Any request for upward revision of quoted HSN code / rate of GST rate on account of ignorance / mistake while quoting shall not be entertained and shall be on account of tenderer.

F. DELIVERY TERMS & CONDITIONS

F-1 The Tenderer will be bound to make supplies as per delivery schedule specified in the Order or as amended by the Corporation failing which Corporation may take appropriate action as per Clause No. F-6 & F-7 of Tender Document.

F-2 Force Majeure:- In the event that the Supplier or any of its subcontractors, or the purchaser is delayed in performing any of its respective obligations under the Contract, and such delay is caused by Force Majeure, including but not limited to war, civil insurrection, fires, floods, epidemics, earthquakes, quarantine restrictions and freight embargoes, such delay may be excused and the period of such delay may be added to the time and performance of the obligation delayed.

F-3. Tenderers shall be bound to supply materials against Purchase Orders placed on them during the contract period of one year which may be further extended by 01 year by mutual consent.

F-4. The delivery schedules may be altered or the Order may be short closed by ALIMCO without assigning any reason by providing 30 days notice.

F-5. The supplies shall be made in proper packing to avoid any damage/loss/pilferage in transit & storage.

F-6. The delivery of the stores shall be made strictly as per delivery schedule conveyed or as modified from time to time. In case the Supplier / Contractor fails to supply the material or provide services as per schedule stipulated in Purchase Order / Work / Service Contract, the Purchaser i.e. the Corporation will have the right to cancel the Purchase Order / Work / Service Contract at the risk and cost of the defaulter contractor/ supplier who shall be liable to compensate the Corporation for loss or inconvenience suffered by it, in addition to the administrative action including suspension, banning etc. which the Corporation may decide to take against the defaulter and to forfeit the EMD /SD/Performance Security to the whole or any part thereof. The Corporation shall also have the right to levy liquidated damages for delays in supply/ execution of the contract. The Liquidated damages shall be levied at the rate of point five percent (i.e. 1/2 % or 0.5%) per week or fraction of a week subject to the maximum of 10% of the contract value.

F-7. The supply of all items shall be completed satisfactorily within the stipulated delivery period of the order failing which ALIMCO reserves the right to obtain / purchase stores from other sources at your sole risk, responsibility and cost. If any higher price has to be paid above the contracted price, the loss which may occur on this account, shall be recovered from the tenderer.

F-8. Other terms & conditions of supplies shall be as stipulated in the Purchase Order to be placed against this tender.

G. INSPECTION AND REPLACEMENT/DISPOSAL OF MATERIAL IN CASE OF REJECTION

G-1. Inspection of supplies will be carried out at the premises only of ALIMCO, KANPUR or to its Auxiliary Production Centers (AAPCs) at Jabalpur, Bengaluru, Bhubaneshwar & Ujjain as the case may be, which shall be final & binding on tenderer.

G-2. In case of local supplier, rejected material shall be lifted/collected from our stores within 10 days after receipt of our rejection advice or latest within 15 days from the date of our letter whichever is earlier, after refunding the payment, if already made to them.

G-3. Unacceptable / rejected material will be returned to the outstation supplier at the suppliers' risk and cost by road on their request on freight to pay basis, only after receipt and acceptance of replacement supplies provided by the suppliers free of cost. Alternatively the Tenderers will have to furnish their bankers' name, address including Code Number alongwith a declaration / undertaking to guarantee collection of documents for returned supplies negotiated through their bank, within 07 days of its presentation.

G-4. If due to any reason, the lifting / collection of rejected material is delayed by the tenderer beyond 15 days the corporation shall be entitled to charge inventory carrying cost for period beyond 15 days. However, Corporation will not hold the rejected materials beyond 45 days & may dispose off the rejected materials as deemed fit at supplier's cost and no claim whatsoever shall be entertained/admissible at all in this respect. Any loss/expenses incurred in this connection would be to the supplier's accounts.

H. GENERAL

H-1. The successful tenderer shall not sub contract the supplies covered under the Purchase Orders.

H-2. Any post tender offer would be rejected summarily and may also result into black-listing of the parties making such offer.

H-3. Any bribe, commission, gifts or advantage given, promised or offered by the Tenderer or on behalf of the Tenderer or his partner, agent or servant or anyone on his or their behalf (whether with or without the knowledge of the Tenderer) to any officer, servant, representative or agent of Corporation in relation to the obtaining or to the execution of this or any other contract with the Corporation shall be in addition to any criminal liability which he may incur, subject the Tenderer to the cancellation of this and all other contracts and also to payment to Corporation of any loss resulting from any such cancellation.

H-4. The tenderers should necessarily enclose the complete specification / technical details / exhaustive literature / printed catalogue of their offered products / equipments indicating any special features of their offered products.

H-5 **General Lien:-** Whenever, under this Purchase Order / Work Contract any sum of money is recoverable from and payable by the contractor, the Company shall be entitled to recover such sum by appropriating in part or in whole the Security Deposit of the Contractor, if a Security is taken from the Contractor. In the event of the Security being in-sufficient or if no Security has been taken from the Contractor, the balance or the total sum recoverable, as may be, shall be deducted from any sum due to the Contractor or which at any time thereafter may become due to the Contractor under this or any other Contract with the Corporation Should this sum be not sufficient to cover the full amount recoverable the Contractor shall pay to the Company on demand the remaining balance due.

J. TERM OF PAYMENT

ALIMCO is a Schedule 'C' Miniratna Category II Central Public Sector Enterprises, registered under Section 8 (Not for Profit motive) of the Companies Act, 2013, (corresponding to Section 25 of the Companies Act, 1956)

- i) Payment of Basic amount will be made within 30 days after receipt of acceptable supplies without any damage / short supplies or from submission of bills whichever is later. However, the GST portion will be payable only after submission of proof / self-certified copy of GST return filed online by the tenderer clearly (duly highlighted) showing invoice/ bill number and amount submitted to ALIMCO.

- ii) Advance payment terms or payment against delivery or terms of payment other than J(i) above are not acceptable to the Corporation. Such Offers will be summarily rejected.
- iii) The Corporation would not bear any overdue interest / demurrage charges for non receipt of material at the Transporter / Railway godown upto a period of 15 days from the date of actual receipt of material at the Transporter / Railway godown.
- iv) All bank charges to be borne by tenderer.
- v) The successful Tenderer will be required to submit their RTGS details duly certified by the Bank or alongwith a crossed/cancelled Cheque in support of the details, as all payments are proposed to be made through RTGS only.

K. RIGHT OF ACCEPTANCE

ALIMCO reserves the right to reject any or all the tenders in part or full and / or to negotiate terms and conditions of supply and to amend the quantity against the Order without assigning any reason thereof. The Corporation also reserves the right to Short close / cancel the Order by giving one month notice at its sole discretion as deemed fit without assigning any reason thereof.

L. THIS IS A FIXED PRICE TENDER. ANY REQUEST FOR RATE REVISION TILL CURRENCY OF P.O. SHALL NOT BE CONSIDERED.

M. Amendment of Purchase Order Quantity

The Corporation has right to amend the Tender/Purchase Order Quantity (enhanced/reduced) in case of change/amendment in the Production schedule during currency of Purchase Order to meet out the Corporation's target/commitments as per customers/Marketing department requirement.

N. Banning, Black-Listing of parties, Suspension of business with them will be dealt as per guidelines of Purchase Policy of the Corporation available on its website – www.alimco.in.

O. The Tenderer are required to provide their e-mail address, postal address and telephones/cell number etc. necessarily on their letter head.

P. ARBITRATION

If any dispute / question or controversy arises, the settlement of which is not herein specifically provided in this Tender / Order/ Contract, the matter in dispute shall be referred to the arbitration of the Chairman and Managing Director of ALIMCO or his nominee and decision of Chairman and Managing Director or his nominee shall be final and binding on both the parties. The provision of INDIAN ARBITRATION & CONCILIATION ACT 1996 as amended from time to time shall apply to such arbitration proceedings. Arbitration proceeding shall be held at Kanpur only and the Kanpur Nagar Court will have jurisdiction in the matter.

Thanking you,

Yours faithfully
For- Artificial Limbs Mfg. Corporation of India

Dy. General Manager (Materials)

Techno-Commercial Bid (TC-Bid) – On line Submission (Cover 1)

Annexure – I

Tender No.: MM/OT/37/AX

**Item:- Kit Consisting of Components for Behind the Ear (BTE) Hearing Aid –
Digital Category- II & III alongwith Batteries & Ear Tips**

Please furnish the following details in the given proforma.

01	<p>Enclose DD for Rs.600/= towards Tender Cost (required to be submitted physically to ALIMCO as specified in the tender and scanned copy to be uploaded in Cover 1 (TC-Bid) OR Enclose, DD for Rs.600/- towards cost of Tender documents if down-loaded from the website of the Corporation (All SSI/MSE Vendor are exempted from Tender Cost on producing Valid Udyog Aadhaar Memorandum only. Scanned copy to uploaded in Cover1).</p>	<p>DD / Bankers Cheque No.....Date..... Banker's Name :-..... i) Registration No.....ii) Valid upto..... iii) Issuing Authority..... iv) Category of Registration..... v) Copy enclosed..... Yes/No</p>
02	<p>EMD of Rs. 15.00 Lakhs towards EMD. (required to be submitted physically to ALIMCO as specified in the tender and scanned copy to be uploaded in Cover 1 (TC-Bid) OR EMD by way of Demand Draft or Banker's Cheque. SSI/MSE Units having valid registration with Udyog Aadhaar Memorandum (UAM) for category of items as against this tender will be exempted from payment of EMD. Such SSI/MSE Tenderers are required to enclose/upload (under cover 1) a certified copy of valid registration certificate of Udyog Aadhaar Memorandum which is mandatory to avail the exemption clearly showing the category of item. If the Registration is for the category of Item other than what has been Tendered by the Corporation, the exemption from EMD will not be allowed/admissible and tenderer needs to submit full amount of EMD as per tender alongwith their TC-Bid only to avoid summarily rejection of their offer. The tenderer claiming EMD exemption based on Udyog Aadhaar Memorandum (UAM) certificate are required to submit and undertaking (please refer Annexure –B-7) alongwith their quote/offer that the items quoted/offered are only for registered items/category of items as have been mentioned in the valid Udyog Aadhaar Memorandum (UAM) certificate and submitting quote contrary (full or part) to the undertaking will cause summarily rejection of their quote/offer.</p>	<p>DD / Bankers Cheque No.....Date..... Amount..... Banker's Name :-..... i) Registration No.....ii) Valid upto..... iii) Issuing Authority..... iv) Category of Registration..... v) Copy enclosed..... Yes/No</p>
03	Copy of GST Registration Certificate, duly signed & stamped, clearly mentioning the GSTIN number.	<p>i) Registration No..... iii) Copy of Certificate Enclosed Yes/No</p>
04	Copy of Income Tax return for the previous financial year 2017-18 i.e. Assessment Year 2018-19, duly signed & stamped.	Copy enclosed – Yes/No
05	The sample (free of Cost & non returnable) of Kit consisting of components for BTE	Enclosed – Yes/No

	<p>comprise of following assemblies alongwith batteries & Ear Tips will be submitted by the tenderer as indicated in Annexure ‘A’ in a separate sealed cover and kept inside the TC-Bid envelope or alongwith as the case may be alongwith Annexure III:-</p> <p>a) Amplifier Assembly b) Receiver Assembly c) Microphone Assembly d) Housing Pair Assembly</p> <p>Kindly note that only Kit consisting of above Assemblies of BTE alongwith Batteries & Ear Tips would be accepted as samples and in no case Assembled BTE will be accepted by the Corporation. The Samples of Kit consisting of Components for BTE Hearing Aid Digital alongwith Batteries and Ear Tips submitted by the tenderer would be the property of ALIMCO and will not be returned in any circumstances and no claim in this respect shall be entertained</p>	
06	Specific Confirmation in the format enclosed at Annexure ‘B1’ to the effect that the material quoted/to be supplied is/will be as per ALIMCO Specifications & drawing alongwith requisite Test Certificate Format to the effect is enclosed at Annexure ‘B-1’.	Confirmation enclosed – Yes/No
07	The tenderer has to submit an undertaking to supply the additional quantity of material equal to 100% of the Order quantity at the same rates and terms & conditions if Ordered within a period of 06 months from the date of last supply or during the validity of Order in the format enclosed at Annexure ‘B-2’.	Undertaking Enclosed - Yes/No
08	The tenderer should have an average annual turnover of not less than Rs. 583.00 Lakh in the relevant field during the last 03 financial years i.e. 2016-17, 2017-18 & 2018-19. In order to authenticate, a certificate regarding average turnover during the above last three financial years from a qualified Chartered Accountant is required to be furnished alongwith ‘TC-Bid’.	Certificate enclosed - Yes/NO
09	The tenderer should submit an undertaking that his/her firm has not been debarred/terminated/blacklisted/put on holiday to participate in the tender by any Govt. Institution, PSUs, State Govt. or Central Govt. Deptt. in the format enclosed at Annexure-B-3.	Undertaking enclosed – Yes / NO
10	The tenderer should submit an undertaking that his/her Offer is valid for acceptance for 90 days from the date of opening of TC Bids in the format enclosed at Annexure-B-4.	Undertaking enclosed - Yes / NO
11	The Tenderer should submit an undertaking that the payment terms of basic amount within 30 days and subsequent payment of GST as specified in the format enclosed at Annexure-B-5 is acceptable to them	Undertaking enclosed - Yes / NO
12	The Tenderer has to undertake a replacement warranty of 24 months of material supplied from the date of receipt of store in ALIMCO. A Confirmation regarding above Warranty for materials offered need to be furnished, as per Annexure –A in the format enclosed at Annexure –B-6.	Undertaking enclosed - Yes / NO
13	The tenderer should submit an undertaking that the items quoted/offered are only for registered items/ category of items as have been mentioned in the valid Udyog Aadhar	Undertaking enclosed - Yes / NO

	Memorandum (UAM) certificate in the format enclosed at Annexure B-7. (To be submitted only by SSI/MSE Units having valid Registration certificate of Udyog Aadhar Memorandum (UAM) Claiming Tender Fee & EMD exemption.).	
14	Technical Compatibility chart regarding specifications of material offered by you vis-à-vis required specifications as per Annexure 'C-1' & 'C-2'.	Enclosed – Yes/No
15	The tenderers have to submit a list of Institutions/Buyers to whom supplies of a minimum 48,000 Kits of components of BTE/Hearing devices has been made in the last 3 years i.e. 2016-17, 2017-18 & 2018-19. Documentary evidences, the copies of Purchase Order and proof of successful execution of Order issue by customer in support of experience in the field. (Copy of such supply orders needs to be enclosed duly signed & stamped)	Enclosed – Yes/No
16	The Tenderer shall have past working experience in the similar field i.e. supply of BTE Kits in last 03 years i.e. FY 2016-17, 2017-18 & 2018-19. The documentary evidence such as copy of purchase order, proof of successful execution of order issued by customer, etc. pertaining to all the three years have to be provided alongwith tender TC Bid (Copy of such supply Orders needs to be enclosed duly signed & stamped)	Enclosed – Yes/No
17	Tender Acceptance Letter	Enclosed – Yes/No

(Signature & Seal)

- Note :**
1. All documents Scanned copy to be uploaded ON LINE using <https://eprocure.gov.in/eprocure/app.in> Cover 1).
 2. However, Original DD towards EMD & tender fee (tender reference number on the back of the Bank Draft) & Sample along clearly mentioning Tender No. **MM/OT/37/AX** and Bid Submission End Date : **17.06.2019**, should be sent by Registered / Speed post Acknowledgement so as to reach the same on or before the Bid submission end date & time addressed to Dy. General Manager (Materials), ALIMCO, G.T. Road, Kanpur-209217 (U.P.). but postal and transit delay may not be condoned in reckoning the tenders for our consideration.

Price Bid (P-Bid) Submission in .xls format as per details given below :-

Tender No. : MM/OT/37/AX

Please furnish the details in the given XLS. Proforma as available / through online on CPP Portal <http://eprocure.gov.in/eprocure/app>

S.NO	FOR SUPPLY TO DESTINATIONS	ANNEXURE DETAILS
1	HQ KANPUR	ANNEXURE –II in xls. formats

1. Maximum quantity which can be delivered/supplied per month may normally be not less than our average monthly requirement:
2. Maximum period required to commence supplies which may normally be not exceeding 30 days from the date of placement of Purchase Order.

NOTE:

- i) The rates should be invariably and Separately quoted for supplies to ALIMCO, H.Q. Kanpur or to its Auxiliary Production Centers (AAPCs) at Jabalpur, Bangalore, Bhubaneshwar & Ujjain as the case may be.
- ii) **The basic Price/rate, GST Taxes, along with HSN code, Packing & Forwarding charges and Freight charges must be mentioned separately & Specifically in the respective .xls formats as available on CPP Portal <http://eprocure.gov.in/eprocure/app>.**

(Signature & Seal)

(TO BE FILLED UP IN DUPLICATE AND ENCLOSED WITH SAMPLES & TC BID)

LIST OF ITEMS BEING SUBMITTED

Tender No. :- MM/OT/37/AX

Date of Opening:- 18.06.2019

Name of Tenderer: - M/s. _____

Following items are being submitted as samples:-

<u>S.No.</u>	<u>Code No.</u>	<u>Description</u>	<u>Make /Brand</u>	<u>Qty.</u>	<u>Remarks</u>
1.					
2.					
3.					
4.					
5.					
6.					
7.					
8.					
9.					
10.					
11.					

Signature with seal & date

- Note:-**
1. Separate samples shall be submitted for each item if required as per Annexure 'A' .
 2. The samples should be submitted alongwith the offer (TC-Bid) duly tagged, stamped & signed with Name of Tenderer and Tender Number for proper and exact identification of samples. If the same is not complied, the Tenderer cannot deny the sample identified by us as their sample & the inspection report of the same.
 3. In case of non submission of sample, the Offer may be rejected.

ANNEXURE 'A'

Open Tender No. : MM/OT/37/AX
Date of Opening : 18.06.2019
Item : Kit Consisting of Components for Behind the Ear (BTE) Hearing Aid – Digital Category- II & III alongwith Batteries & Ear Tips

Sl. No.	Code No.	Nomenclature	Estimated Required Quantity
01	TDOE160Z0	Kit Consisting of Components for Behind the Ear (BTE) Hearing Aid - Digital Category- II alongwith Battery & Ear Tips (AS PER SPECIFICATIONS / DRAWINGS ATTACHED AT ANNEXURE – D-1)	25,000 Kits
02	TDOE170Z0	Kit Consisting of Components for Behind the Ear (BTE) Hearing Aid - Digital Category- III alongwith Battery & Ear Tips (AS PER SPECIFICATIONS / DRAWINGS ATTACHED AT ANNEXURE – D-2)	1,35,000 Kits

Note:-

1. Tenderers need to submit Five Kits consisting of components for Behind the Ear (BTE) Hearing Aid Digital each for category –II and category –III alongwith Batteries and Ear Tips in case they wish to participate in both the categories as stipulated at Sl. No. 1 and 2 above, duly tagged, stamped & signed with Name of Tenderer and Tender Number for proper and exact identification of samples. In case tenderer fails to comply with the above instructions the Corporation has the right to identify the unmarked samples and the inspection report of such samples will be binding on the tenderer. Tenderers may submit Assembly procedure of BTE Hearing Aid, if any, alongwith drawings.
2. **In case three samples of each out of five samples submitted by you, will meet the required technical specifications after testing, your sample will be treated as technically accepted.**
3. If the sample required as above is / are not submitted alongwith TC-BID, No subsequent opportunity will be given to submit the sample.
4. **The Samples (free of cost & non-returnable) of Kit consisting of Components for BTE Hearing Aid- Digital alongwith Batteries and Ear tips submitted by the tenderer would be the property of ALIMCO and sample will not be return back in any circumstances and no claim in this respect shall be entertained.**
5. Tenderer is not allowed to submit the samples of tendered items/ Hearing Aids/BTE Kits which are supplied by other vendors against the Purchase Order if any placed by the Corporation. The vendors are required to submit their own samples instead of procuring the samples of the Corporation and re-submitting the same against the tender failing which the same will not be taken in to consideration & processed further.

6. Jigs, Fixtures & Dies for manufacture of the above items required, if any, is to be developed by the party at their own cost.
7. This is a fixed price tender. Any request for rate revision till currency of P.O. shall not be considered.
8. The tentative quantities likely to be covered by Purchase Order are indicated above. The material would be required to be supplied on staggered delivery schedule to be indicated in Purchase Order or as required by the Corporation.
9. The total requirement of the above material may vary substantially up or down as per requirement of the Corporation & successful tenderer will be required to arrange the supplies accordingly.
10. The tentative monthly requirement will be approx 1/12th of the quantity indicated above subject to be change by the Corporation which may vary substantially up or down as per requirement of the Corporation.
11. Maximum period required to commence supplies which may normally be not exceeding 30 days from the date of placement of Purchase Order.
12. **You are required to offer replacement warranty of 24 months from the date of receipt of stores in ALIMCO**

For Artificial Limbs Manufacturing Corporation Of India

Dy. General Manager (Materials)

(On Letter Head of the Tenderer)

ANNEXURE 'B-1'

UNDERTAKING

We hereby confirm that the material quoted/to be supplied is/will be as per ALIMCO Specification & Drawings.

Dated:

Authorised Signatory:

Name :-

Designation :-

Seal :-

(On Letter Head of the Tenderer)

Annexure – ‘B-2’

UNDERTAKING

We hereby undertake to supply the additional quantity of material equal to 100% of the Order quantity at the same rates, terms & conditions if ordered within a period of six months from the date of last supply or during the validity of the Order.

Dated:

Authorised Signatory :

Name :-

Designation :-

Seal :-

(On Letter Head of the Tenderer)

ANNEXURE 'B-3'

UNDERTAKING

We hereby undertake that our Firm has not been debarred/terminated/blacklisted/put on holiday to participate in the Tender by any Govt. Institution, PSU, State Govt. or Central Govt. Deptt.

Dated:

Authorised Signatory :

Name :-

Designation :-

Seal :-

(On Letter Head of the Tenderer)

ANNEXURE 'B-4'

UNDERTAKING

We hereby undertake that our Offer is valid for acceptance for 90 days from the date of opening of Techno-Commercial Bid (TC-Bid).

Dated:

Authorised Signatory:

Name :-

Designation :-

Seal :-

(On Letter Head of the Tenderer)

ANNEXURE 'B-5'

UNDERTAKING

We hereby confirm that payment of basic value within 30 days after supply & acceptance/approval of material or Submission of bill, whichever is later, is acceptable to us. However, the GST portion shall be paid only after submission of proof / self-certified copy of GST Quarterly Return (GSTR-1) filed online by the tenderer clearly (duly highlighted) showing invoice/ bill number and amount to be submitted to ALIMCO so as to enable the Corporation to avail GST input credit after matching of the GST return and Invoice submitted in the Corporation. In case, non-matching no payment of GST shall be made.

Dated:

Authorised Signatory:

Name :-

Designation :-

Seal :-

(On Letter Head of the Tenderer)

ANNEXURE 'B-6'

UNDERTAKING

We hereby undertake that the material to be supplied by us shall have a replacement Warranty of 24 Months from the date of receipt of store in ALIMCO.

Dated:

Authorised Signatory:

Name :-

Designation :-

Seal :-

(On Letter Head of the Tenderer)

ANNEXURE 'B-7'

**(TO BE SUBMITTED ONLY BY SSI/MSE UNITS CLAIMING TENDER FEE & EMD
EXEMPTION ON THE BASIS OF UDYOG AADHAAR MEMORANDUM)**

UNDERTAKING

We hereby undertake that, the quote/Offer submitted by us against this tender is only for Items/category of items as tendered and same also have been mentioned/specified in our valid Udyog Aadhar Memorandum (UAM) Certificate being enclosed alongwith TC-Bid.

Dated:

Authorised Signatory:

Name :-

Designation :-

Seal :-

Technical Compatibility Chart

Tender No. : MM/OT/37/AX

Due date of Opening : 18.06.2019

Item Code / Nomenclature : LH 71 / COMPONENTS FOR BEHIND THE EAR (BTE) HEARING AID – DIGITAL,
CATEGORY – II CONSISTING OF FOLLOWINGS :

Sl. No.	Our Requirement	Offer Details	Compliance/Remarks
1	<p>Amplifier Assembly</p> <p>(i) Complete Digital Amplifier assembled with SMD components, Tone control (N-H) & MPO Controls shall be provided either through trimmer or push button, Positive(+) & Negative(-) Battery Contacts plated with corrosion resistant material, Switch for Microphone & Tele - Coil mode change, Automatic Gain Control Facility (AGC), Masking / Insulation on both side of Amplifier Assembly. Cleaned / unmasked soldering points for Receiver Assembly & Microphone Assembly.</p> <p>(ii) Volume control : By switch or Rotary type potentiometer with min. 4 stage numbering like 1,2,3 & 4 etc.</p> <p>(iii) ON-OFF : On - Off Switch to apply power either through switch or the battery compartment cover/door.</p> <p>(iv) The Amplifier Assembly shall operate on nominal 1.3 V Zinc - Air Battery/ NiMH rechargeable battery .</p>		

Sl. No.	Our Requirement	Offer Details	Compliance/Remarks
	<p>(v) Electro-acoustic Characteristics :</p> <p>(A) Max. OSPL 90 : 125 dB</p> <p>(B) HF Average OSPL 90 : 115 dB to 124 dB</p> <p>(C) HF Average Full On Gain : 50 dB (min.) (At 50/60 dB Input)</p> <p>(D) Frequency Range : At Least between 200 Hz to 4000 Hz</p> <p>(E) Total Harmonic Distortion : Should not exceed 7 % at 1.3 V Nominal Battery voltage measured at frequency 500,800 & 1600 Hz at RTG position.</p> <p>(F) Battery Current : ≤ 10 mA</p> <p>(G) Equivalent Input Noise Level : ≤ 30 dB SPL</p> <p>(H) Induction Coil Sensitivity : 85 dB (min.) (at 10 mA /m)</p> <p>(I) AGC Characteristics :</p> <p>(i) Steady state input / Output characteristics : With the measured and specified curves matched at the point corresponding to 70 dB input SPL, the measured curve at 50 & 90 dB input SPL from the curves specified by the manufacturer for the model by more than ± 5 dB.</p> <p>(ii) Dynamic output characteristics : The attack & release times shall be within ± 5 milliseconds or ± 50 percent whichever is larger, of the values specified by the manufacturer for the model.</p>		

Sl. No.	Our Requirement	Offer Details	Compliance/Remarks
2.	<p><u>Receiver Assembly</u></p> <p>Receiver suitable for the BTE Hearing Aid - Digital ,Receiver completely assembled with cushion & coupler, suitable length of Litz wires to be soldered to receiver points with colour coding for assembly with Amplifier Assembly. Receiver Acoustic Connection with or without Receiver Shield shall be suitable for assembly of receiver in Housing pair assembly of BTE Hearing Aid .Masking /Insulation shall be coated on soldering points & litz wires of Receiver Assembly. Other ends of Litz wires shall be unmasked/not insulated suitable to soldering on Amplifier Assembly .Receiver shall be able to work on nominal battery voltage 1.3 V.</p>		
3	<p><u>Microphone Assembly</u></p> <p>Microphone suitable for BTE Hearing Aid - Digital .Microphone completely assembled with Boot & nozzle. Suitable length of Litz wires to be soldered to Microphone points with colour coding for assembly with amplifier assembly OR Microphone with flat strip connector to be soldered to Microphone points for assembly with amplifier assembly. Masking/Insulation shall be coated on soldering points &Litz wires/flat strip connector of Microphone assembly .Other ends of Litz wires/flat strip connector shall be unmasked/not insulated suitable to soldering on Amplifier Assembly. Microphone shall be able to work on nominal battery voltage 1.3 V.</p>		
4	<p><u>Housing Pair Assembly</u></p> <p>(A) Housing Pair with “ALIMCO” & “ISI” mark printing as per drawing enclosed. Trimmer door, Trimmer Label shall be printed as N-H & MPO and suitable indication of Trimmer position, Battery Door. Suitable Ear Hook for Housing pair assembly, plated with corrosion resistant material cross pan head tapping screws suitable for Housing pair assembly.</p>		

Sl. No.	Our Requirement	Offer Details	Compliance/Remarks
	<p>(B) Housing Pair Assembly as per over all dimensions –</p> <ul style="list-style-type: none"> (i) Length : 60 mm max. (ii) Width : 25 mm max. (iii) Thickness : 15 mm max. (iv) Material : ABS Gd. 1 (v) Colour : Cinamon (Skin), Cream, Brown, Black <p>(C) Design : The housing should be so designed that the method of battery replacement does not require the use of tools, either to open/close the battery compartment or to replace the batteries.</p> <p>(D) Mass : The mass of the kit of all the 4 components mentioned above taken together excluding the battery, ear Insert & adaptor shall not exceed 10 gm excluding the ear Tip/mould.</p> <p>(E) Serial Number to be printed on Battery Door/Housing as per ALIMCO advice.</p>		
5	<u>Shelf Life of Kit</u> : 24 Months		
6	<u>Test Report</u> - May provide the Hearing Aid Analyser test report for the sample quoted.		
7	<u>Packing Requirements</u> : Items/components shall be packed so as to avoid damage during transportation & handling.		

Technical Compatibility Chart

Tender No. : MM/OT/37/AX

Due date of Opening : 18.06.2019

Item Code / Nomenclature : LH 72 / COMPONENTS FOR BEHIND THE EAR (BTE) HEARING AID – DIGITAL,
CATEGORY – III CONSISTING OF FOLLOWINGS :

Sl. No.	Our Requirement	Offer Details	Compliance/Remarks
1.	<p><u>Amplifier Assembly</u></p> <p>(i) Complete Digital Amplifier assembled with SMD components, Tone control (N-H) & MPO Controls shall be provided either through trimmer or push button, Positive(+) & Negative(-) Battery Contacts plated with corrosion resistant material, Switch for Microphone & Tele - Coil mode change, Automatic Gain Control Facility (AGC), Masking / Insulation on both side of Amplifier Assembly. Cleaned /un masked soldering points for Receiver Assembly & Microphone Assembly.</p> <p>(ii) Volume Control : By switch or Rotary type potentiometer with min. 4 stage numbering like 1, 2, 3 & 4 etc.</p> <p>(iii) ON-OFF : On – Off Switch to apply power either through switch or the battery compartment cover/door.</p> <p>(iv) The Amplifier Assembly shall operate on nominal 1.3 V Zinc – Air Battery/ NiMH rechargeable battery.</p>		

Sl. No.	Our Requirement	Offer Details	Compliance/Remarks
	<p>(v) <u>Electro-acoustic Characteristics</u></p> <p>(A) Max. OSPL 90 : 135 dB</p> <p>(B) HF Average OSPL 90 : 125 dB to 134 dB</p> <p>(C) HF Average Full On Gain : 60 dB (min.) (At 50 dB Input)</p> <p>(D) Frequency Range : At Least between 200 Hz to 4000 Hz</p> <p>(E) Total Harmonic Distortion - Should not exceed 7% at 1.3 V Nominal Battery voltage measured at frequency 500,800 & 1600 Hz at RTG position.</p> <p>(F) Battery Current : ≤ 15 mA</p> <p>(G) Equivalent Input Noise Level : ≤ 30 dB SPL</p> <p>(H) Induction Coil Sensitivity : 95 dB (min.) (at 10 mA /m)</p> <p>(I) <u>AGC Characteristics</u></p> <p>(i) Steady state input/ Output characteristics : With the measured and specified curves matched at the point corresponding to 70 dB input SPL, the measured curve at 50 & 90 dB input SPL from the curves specified by the manufacturer for the model by more than ± 5 dB.</p> <p>(ii) Dynamic output Characteristics : The attack & release times shall be within ± 5 milliseconds or ± 50 percent whichever is larger, of the values specified by the manufacturer for the model.</p>		

Sl. No.	Our Requirement	Offer Details	Compliance/Remarks
2	<p><u>Receiver Assembly</u></p> <p>Receiver suitable for the BTE Hearing Aid - Digital ,Receiver completely assembled with cushion & coupler, suitable length of Litz wires to be soldered to receiver points with colour coding for assembly with Amplifier Assembly. Receiver Acoustic Connection with or without Receiver Shield shall be suitable for assembly of receiver in Housing pair assembly of BTE Hearing Aid .Masking /Insulation shall be coated on soldering points & litz wires of Receiver Assembly. Other ends of Litz wires shall be unmasked/not insulated suitable to soldering on Amplifier Assembly. Receiver shall be able to work on nominal battery voltage 1.3 V.</p>		
3	<p><u>Microphone Assembly</u></p> <p>Microphone suitable for BTE Hearing Aid - Digital .Microphone completely assembled with Boot & nozzle. Suitable length of Litz wires to be soldered to Microphone points with colour coding for assembly with amplifier assembly OR Microphone with flat strip connector to be soldered to Microphone points for assembly with amplifier assembly. Masking/Insulation shall be coated on soldering points &Litz wires/flat strip connector of Microphone assembly .Other ends of Litz wires/flat strip connector shall be unmasked/not insulated suitable to soldering on Amplifier Assembly. Microphone shall be able to work on nominal battery voltage 1.3 V.</p>		
4	<p><u>Housing Pair Assembly</u></p> <p>(A) Housing Pair with “ALIMCO” & “ISI” mark printing as per drawing enclosed. Trimmer door, Trimmer Label shall be printed as N-H & MPO and suitable indication of Trimmer position, Battery Door. Suitable Ear Hook for Housing pair assembly, plated with corrosion resistant material cross pan head tapping screws suitable for Housing pair assembly.</p>		

Sl. No.	Our Requirement	Offer Details	Compliance/Remarks
	<p>(B) Housing Pair Assembly as per over all dimensions-</p> <ul style="list-style-type: none"> (i) Length : 60 mm max. (ii) Width : 25 mm max. (iii) Thickness : 15 mm max. (iv) Material : ABS Gd. 1 (v) Colour : Cinamon (Skin), Cream, Brown, Black <p>(C) <u>Design</u></p> <p>The housing should be so designed that the method of battery replacement does not require the use of tools, either to open/close the battery compartment or to replace the batteries.</p> <p>(D) <u>Mass</u></p> <p>The mass of the kit of all the 4 components mentioned above taken together excluding the battery, ear Insert & adaptor shall not exceed 10 gm excluding the ear Tip/mould.</p> <p>(E) Serial Number to be printed on Battery Door/Housing as per ALIMCO advice.</p>		
5	<u>Shelf Life of Kit</u> - 24 Months		
6	<u>Test Report</u> - May provide the Hearing Aid Analyser test report for the sample quoted.		
7	<u>Packing Requirements</u> - Items/components shall be packed so as to avoid damage during transportation & handling.		

	5	4	3	2	1																																													
G	KIT CONSISTING OF COMPONENTS FOR BEHIND THE EAR (BTE) HEARING AID - DIGITAL, CATEGORY-II ALONG WITH BATTERY & EAR TIPS (TD 0 E 16 0 Z0)				G																																													
F	CONSISTING OF FOLLOWINGS : -				F																																													
E	Sl.No.	PRODUCT No.	B.O.No.	NOMENCLATURE	QTY/UNIT																																													
D	1.	TD 0 E 16 0 00	LH 71	COMPONENTS FOR BEHIND THE EAR(BTE) HEARING AID-DIGITAL,CATEGORY-II	01 SET																																													
C	2.	TD 0 E 11 0 00 OR TD 0 E 21 0 00	EH 87 EH 86	675 ZINC - AIR BATTERY 13 ZINC - AIR BATTERY	37 Nos.																																													
B	3.	-----	LH 22	EAR TIP SOFT WITH ADOPTER AND TUBE (LARGE SIZE)	01 No.																																													
A	4.	-----	LH 45	EAR TIP SOFT WITH ADOPTER AND TUBE (MEDIUM SIZE)	01 No.																																													
	5.	-----	LH 66	EAR TIP SOFT WITH ADOPTER AND TUBE (CHILD SIZE)	01 No.																																													
	RELATED DRAWING TO BE REFERRED FOR DETAILS.																																																	
<table border="1" style="width: 100%; border-collapse: collapse;"> <tr> <td style="width: 10%;">SNo.</td> <td style="width: 15%;">REGION</td> <td style="width: 30%;">REVISION</td> <td style="width: 10%;">DATE</td> <td style="width: 10%;">SIGN</td> </tr> <tr> <td colspan="5" style="text-align: center;"> REVISIONS ARTIFICIAL LIMBS MANUFACTURING CORPORATION OF INDIA KANPUR </td> </tr> <tr> <td>DGN</td> <td><i>Polish</i></td> <td>NOM</td> <td colspan="2">KIT CONSISTING OF COMPONENTS FOR BEHIND THE EAR (BTE) HEARING AID - DIGITAL,CATEGORY-II ALONG WITH BATTERY & EAR TIPS</td> </tr> <tr> <td>DRN</td> <td><i>Polish</i></td> <td>MTL</td> <td colspan="2"></td> </tr> <tr> <td>CHD</td> <td><i>Polish</i></td> <td>TOL</td> <td colspan="2"> INTEGER ONLY ±0.500 mm ONE PLACE DECIMAL ±0.250 mm TWO PLACE DECIMAL ±0.125 mm UNLESS SPECIFIED </td> </tr> <tr> <td>DIM</td> <td>IN mm</td> <td>FIN</td> <td colspan="2"></td> </tr> <tr> <td>SCALE</td> <td>NTS</td> <td></td> <td colspan="2"></td> </tr> <tr> <td>APP</td> <td><i>Polish</i></td> <td></td> <td colspan="2"></td> </tr> <tr> <td>DATE</td> <td>09.07.2016</td> <td>DRG No:-</td> <td>TD 0 E 16 0 Z0</td> <td>SHEET</td> </tr> </table>						SNo.	REGION	REVISION	DATE	SIGN	REVISIONS ARTIFICIAL LIMBS MANUFACTURING CORPORATION OF INDIA KANPUR					DGN	<i>Polish</i>	NOM	KIT CONSISTING OF COMPONENTS FOR BEHIND THE EAR (BTE) HEARING AID - DIGITAL,CATEGORY-II ALONG WITH BATTERY & EAR TIPS		DRN	<i>Polish</i>	MTL			CHD	<i>Polish</i>	TOL	INTEGER ONLY ±0.500 mm ONE PLACE DECIMAL ±0.250 mm TWO PLACE DECIMAL ±0.125 mm UNLESS SPECIFIED		DIM	IN mm	FIN			SCALE	NTS				APP	<i>Polish</i>				DATE	09.07.2016	DRG No:-	TD 0 E 16 0 Z0	SHEET
SNo.	REGION	REVISION	DATE	SIGN																																														
REVISIONS ARTIFICIAL LIMBS MANUFACTURING CORPORATION OF INDIA KANPUR																																																		
DGN	<i>Polish</i>	NOM	KIT CONSISTING OF COMPONENTS FOR BEHIND THE EAR (BTE) HEARING AID - DIGITAL,CATEGORY-II ALONG WITH BATTERY & EAR TIPS																																															
DRN	<i>Polish</i>	MTL																																																
CHD	<i>Polish</i>	TOL	INTEGER ONLY ±0.500 mm ONE PLACE DECIMAL ±0.250 mm TWO PLACE DECIMAL ±0.125 mm UNLESS SPECIFIED																																															
DIM	IN mm	FIN																																																
SCALE	NTS																																																	
APP	<i>Polish</i>																																																	
DATE	09.07.2016	DRG No:-	TD 0 E 16 0 Z0	SHEET																																														
	5	4																																																

PRODUCT No.	B.O.No.	NOMENCLATURE	QTY.
TD 0 E 16 0 00	LH 71	COMPONENTS FOR BEHIND THE EAR (BTE) HEARING AID-DIGITAL, CATEGORY-II	01

SPECIFICATIONS :-COMPONENTS FOR BEHIND THE EAR (BTE) HEARING AID-DIGITAL, CATEGORY-II CONSISTING OF FOLLOWINGS:-

(i) Amplifier Assembly:-

Complete digital Amplifier assembled with SMD components, Tone control (N-H) & MPO Controls shall be provided either through trimmer or push button, Positive (+) & Negative(-) Battery Contacts plated with corrosion resistant material, Switch for microphone & Tele -Coil mode change, Automatic Gain Control Facility (AGC), masking/Insulation on both side of Amplifier assembly. Cleaned/unmasked soldering points for Receiver Assembly & Microphone Assembly.

Volume Control:- By switch or Rotary type potentiometer with min.4 stage numbering like 1,2,3 & 4 etc.

ON-OFF :- On- Off switch to apply power either through switch or the battery compartment cover/door.

The Amplifier Assembly shall operate on nominal 1.3V Zinc - Air Battery/NiMH rechargeable battery.

Electro - acoustic Characteristics :-

- (a) Max. OSPL 90 : 125dB
- (b) HF Average OSPL 90 : 115dB to 124dB
- (c) HF Average Full on gain (At 50/60db input) : 50dB (min.)
- (d) Frequency Range : At least between 200Hz to 4000Hz
- (e) Total Harmonic Distortion : Should not exceed 7% at 1.3V Nominal Battery voltage measured at frequency 500,800 & 1600Hz at RTG position
- (f) Battery Current : ≤10 mA
- (g) equivalent input Noise Level : ≤30 dB SPL
- (h) Induction Coil Sensitivity (At 10 mA/m) : 85 dB (min.)
- (i) AGC Characteristics :
 - (i) Steady state input/output characteristics : With the measured and specified curves matched at the point corresponding to 70 dB input SPL, the measured curve at 50 & 90 dB input SPL from the curves specified by the manufacturer for the model by more than ±5 dB.
 - (ii) Dynamic output characteristics : The attack & release times shall be within ±5 milliseconds or ±50% whichever is larger, of the values specified by the manufacturer for the model.

(ii) Receiver Assembly:-

Receiver suitable for the BTE Hearing Aid - Digital, Receiver completely assembled with cushion & coupler, suitable length of Litz wires to be soldered to receiver points with colour coding for assembly with Amplifier Assembly. Receiver Acoustic Connection with or without Receiver Shield shall be suitable for assembly of receiver in Housing pair assembly of BTE Hearing Aid. Masking /Insulation shall be coated on soldering points & litz wires of Receiver Assembly. Other ends of Litz wires shall be unmasked/not insulated suitable to soldering on Amplifier Assembly. Receiver shall be able to work on nominal battery voltage 1.3 V.

(iii) Microphone Assembly:-

Microphone suitable for BTE Hearing Aid - Digital. Microphone completely assembled with Boot & nozzle. Suitable length of Litz wires to be soldered to Microphone points with colour coding for assembly with amplifier assembly OR Microphone with flat strip connector to be soldered to Microphone points for assembly with amplifier assembly. Masking/Insulation shall be coated on soldering points & Litz wires/flat strip connector of Microphone assembly. Other ends of Litz wires/flat strip connector shall be unmasked/not insulated suitable to soldering on Amplifier Assembly. Microphone shall be able to work on nominal battery voltage 1.3 V.

(iv) Housing Pair Assembly:-

Housing Pair with "ALIMCO" & "ISI" Mark printing as per fig.1 shown below. Trimmer door, Trimmer Label shall be printed as N-H & MPO and suitable indication of Trimmer position, Battery Door, Suitable Ear Hook For Housing pair assembly, plated with corrosion resistant material cross pan head tapping screws suitable for Housing pair assembly. Housing Pair Assembly as per over all dimensions :-

- Length : 60mm Max.
- Width : 25mm Max.
- Thickness : 15mm Max.
- Material : ABS Gd.1
- Colour : Cinamon (Skin), Cream, Brown, Black
- Design : The housing should be so designed that the method of battery replacement does not require the use of tools, either to open/close the battery compartment or to replace the batteries.
- Mass : The mass of the kit of all the 4-components mentioned above taken together excluding the battery, ear Insert & adaptor shall not exceed 10gm excluding the ear Tip/mould

Serial Number to be printed on Battery Door /Housing as per ALIMCO advice.

- (v) Shelf Life of Kit : 24 Months
- (vi) Test Report : May provide the Hearing Aid Analyser test report for the sample quoted.
- (vii) Packing Requirement : Items/Components shall be packed so as to avoid damage during transportation & handling.

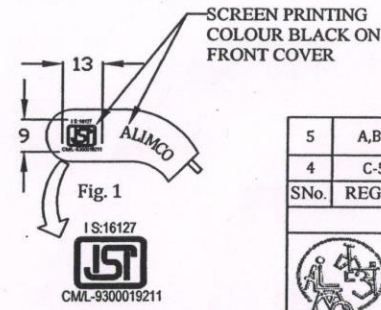

NOTE:-
1. SAMPLE OF SCREEN PRINTING TO BE GOT APPROVED BEFORE SUPPLY.

5	A,B-10	SPECIFICATION OF RECEIVER & MICROPHONE ASSY MODIFIED	28.05.18	
4	C-5	ISI MARK WITH CM/L.No. ADDED	16.01.17	
SNo.	REGION	REVISION	DATE	SIGN
REVISIONS				
ARTIFICIAL LIMBS MANUFACTURING CORPORATION OF INDIA KANPUR				
DGN	Wish	NOM	COMPONENTS FOR BEHIND THE EAR (BTE) HEARING AID-DIGITAL, CATEGORY-II	
DRN		MTL		
CHD		HEAT		
DIM	IN mm	TREATMENT		
SCALE	NTS	SURFACE TREATMENT		
APP	col/DDY		B.O. No. LH 71	REV SHEET 5 1 OF 1
DATE	18.02.2015		DRG No. TD 0 E 16 0 00	

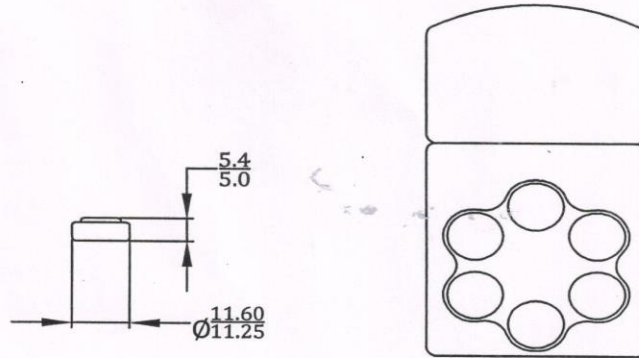

PACKING REQUIRMENT

MTL:- (EH 87)

675 ZINC AIR BATTERY

- NOMINAL VOLTAGE - 1.4V
- CAPACITY - 600mAh Approx
- BATTERY SIZE - 675 (PR 44)
- AVERAGE WEIGHT - 1.70gm Approx
- TERMINALS - FLAT
- SHELF LIFE - 03 YEARS MIN.

NOTE:-

1. ONE PACKET OF BATTERIES (A SEALED PACKET OF 6 NOS. BATTERIES) USED IN BTE DIGITAL TYPE HEARING AIDS.

3.	D - 5	SPECIFICATION OF EH 87 MODIFIED	28.05.18	<i>[Signature]</i>
2.		DRAWING REDESIGN & REDRAWN	08.07.16	<i>[Signature]</i>
SNo.	REGION	REVISION	DATE	SIGN

REVISIONS



ARTIFICIAL LIMBS
MANUFACTURING CORPORATION
OF INDIA
KANPUR



DGN	<i>[Signature]</i>	NOM	675 ZINC AIR BATTERY	
DRN	<i>[Signature]</i>	MTL	INDICATED	
CHD	<i>[Signature]</i>	TOL	INTEGER ONLY ±0.500 mm	UNLESS SPECIFIED
DIM	IN mm		ONE PLACE DECIMAL ±0.250 mm	
SCALE	NTS	FIN	TWO PLACE DECIMAL ±0.126 mm	
APP	<i>[Signature]</i>	DRG No:-	TD 0 E 11 0 00	REV 3 SHEET 10F1
DATE	21.04.2009			

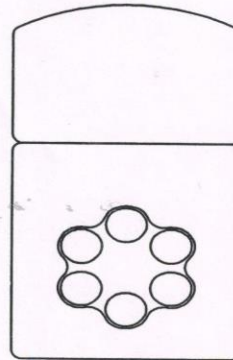
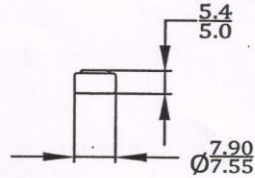

PACKING REQUIRMENT

MTL:- (EH 86)

13 ZINC AIR BATTERY

- NOMINAL VOLTAGE - 1.4V
- CAPACITY - 310mAh Approx
- BATTERY SIZE - 13 (PR 48)
- AVERAGE WEIGHT - 0.80gm Approx
- TERMINALS - FLAT
- SHELF LIFE - 03 YEARS MIN.

NOTE:-

1. ONE PACKET OF BATTERIES (A SEALED PACKET OF 6 NOS. BATTERIES) USED IN BTE DIGITAL TYPE HEARING AIDS.

3.	D - 5	SPECIFICATION OF EH 86 MODIFIED	28.05.18	<i>[Signature]</i>
2.	---	DRAWING REDESIGN & REDRAWN	08.07.16	<i>[Signature]</i>
SNo.	REGION	REVISION	DATE	SIGN

REVISIONS



ARTIFICIAL LIMBS
MANUFACTURING CORPORATION
OF INDIA
KANPUR



DGN	<i>[Signature]</i>	NOM	13 ZINC AIR BATTERY	
DRN	<i>[Signature]</i>	MTL	INDICATED	
CHD	<i>[Signature]</i>	TOL	INTEGER ONLY ±0.500 mm	UNLESS SPECIFIED
DIM	IN mm		ONE PLACE DECIMAL ±0.250 mm	
SCALE	NTS		TWO PLACE DECIMAL ±0.125 mm	
APP	<i>[Signature]</i>	FIN	---	
DATE	27.01.2010	DRG No:- TD 0 E 21 0 00		REV 3 SHEET 1 OF 1

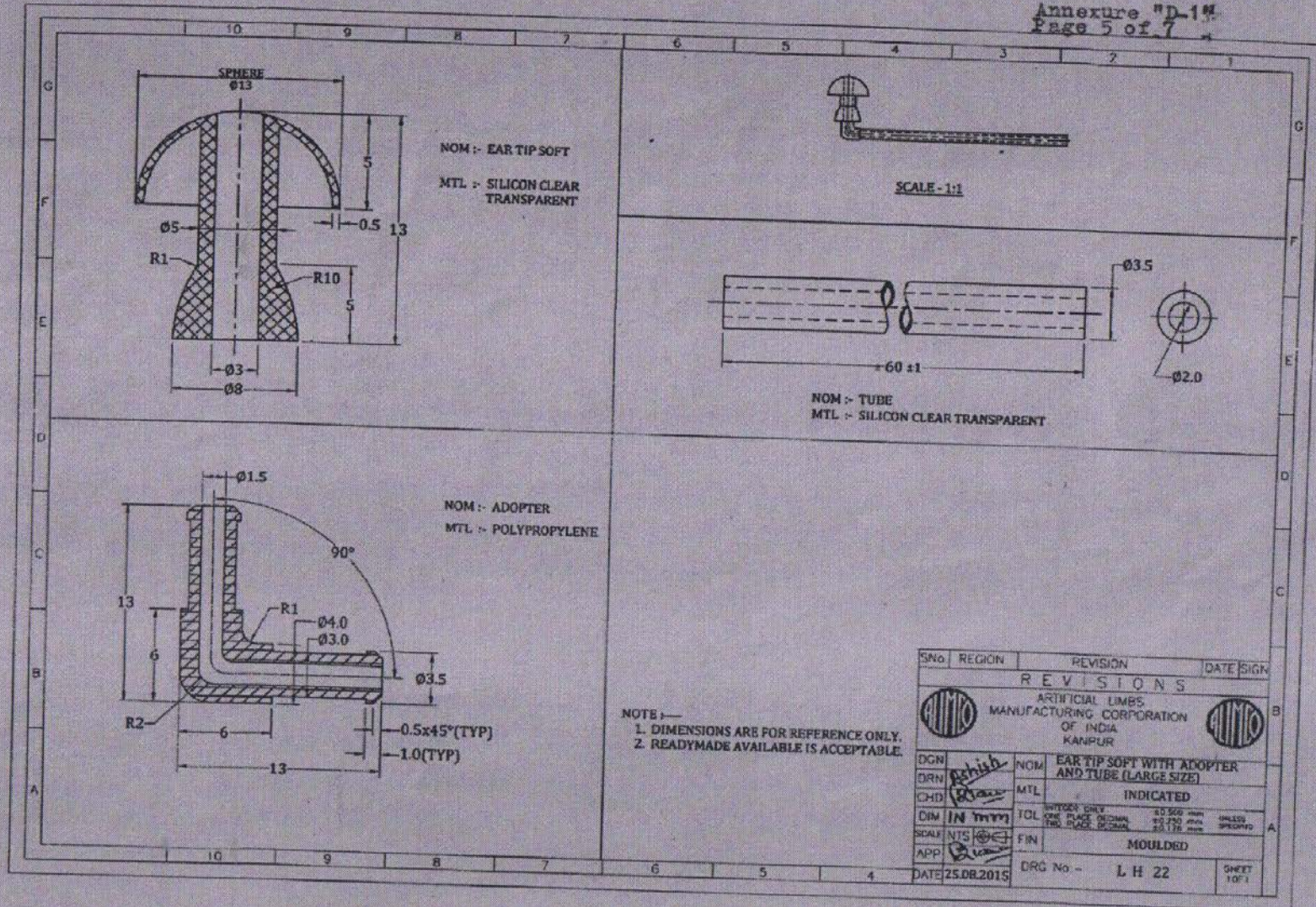

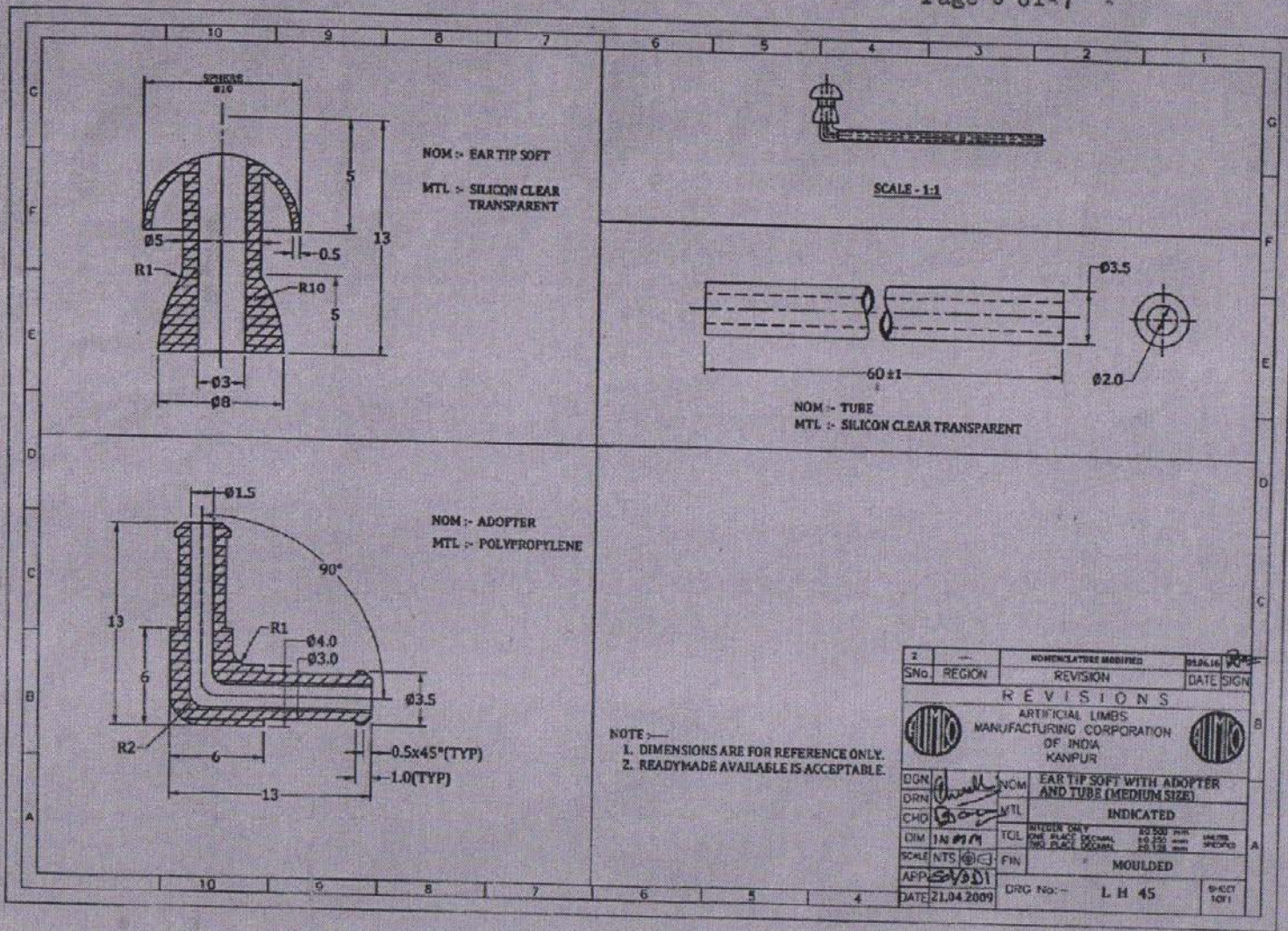

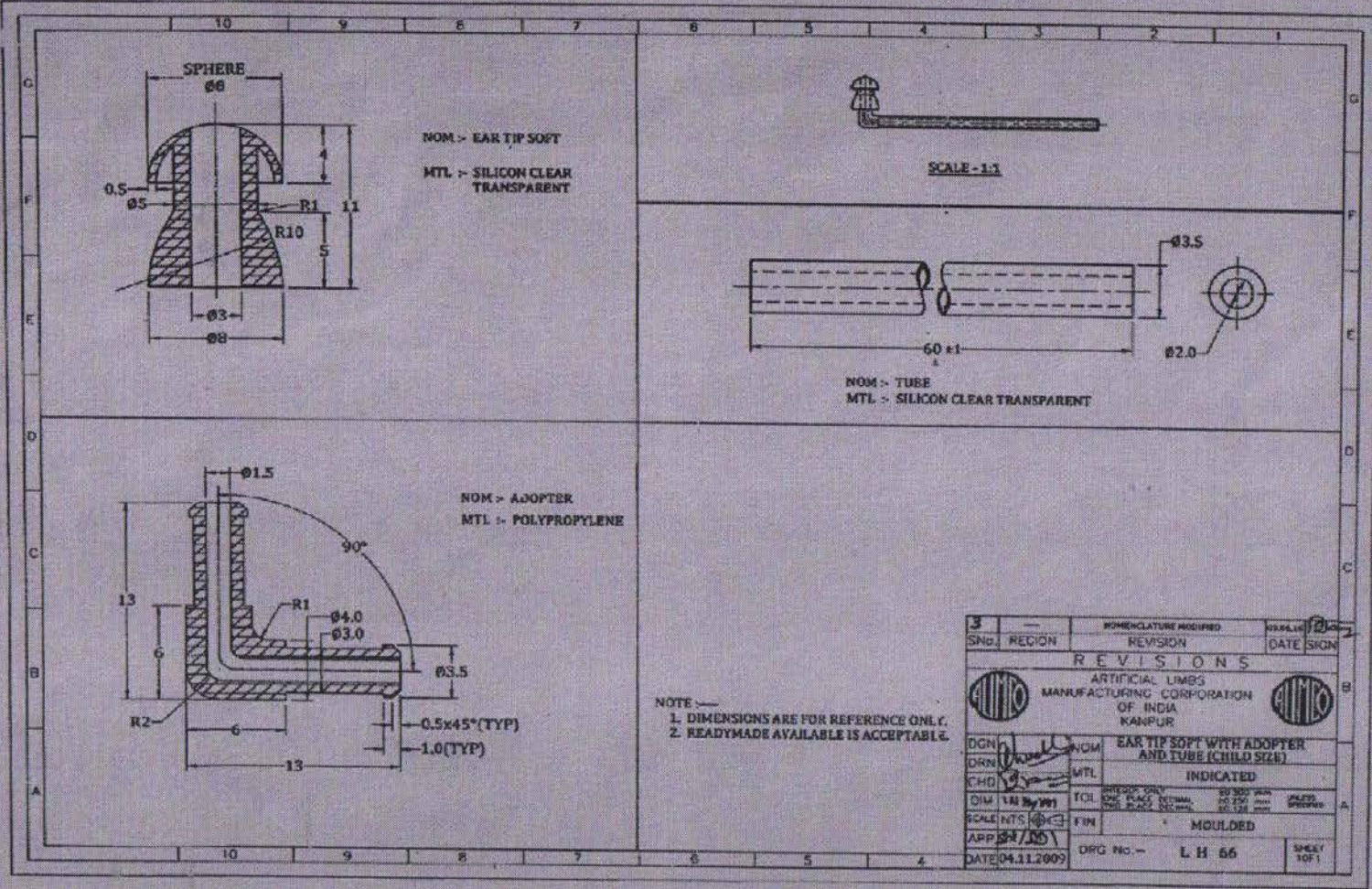

	5	4	3	2	1																																																			
G	<p>KIT CONSISTING OF COMPONENTS FOR BEHIND THE EAR (BTE) HEARING AID - DIGITAL, CATEGORY-III ALONG WITH BATTERY & EAR TIPS (TD 0 E 17 0 Z0)</p>					G																																																		
F	<p>CONSISTING OF FOLLOWINGS :-</p>					F																																																		
E	Sl.No.	PRODUCT No.	B.O.No.	NOMENCLATURE	QTY/UNIT	E																																																		
D	1.	TD 0 E 17 0 00	LH 72	COMPONENTS FOR BEHIND THE EAR(BTE) HEARING AID-DIGITAL, CATEGORY-III	01 SET	D																																																		
C	2.	TD 0 E 11 0 00 OR TD 0 E 21 0 00	EH 87 EH 86	675 ZINC - AIR BATTERY 13 ZINC - AIR BATTERY	37 Nos.	C																																																		
B	3.	-----	LH 22	EAR TIP SOFT WITH ADOPTER AND TUBE (LARGE SIZE)	01 No.	B																																																		
A	4.	-----	LH 45	EAR TIP SOFT WITH ADOPTER AND TUBE (MEDIUM SIZE)	01 No.	A																																																		
	5.	-----	LH 66	EAR TIP SOFT WITH ADOPTER AND TUBE (CHILD SIZE)	01 No.																																																			
	<p>RELATED DRAWING TO BE REFERRED FOR DETAILS.</p>																																																							
	<table border="1" style="width: 100%; border-collapse: collapse;"> <tr> <td style="width: 5%;">SNo.</td> <td style="width: 20%;">REGION</td> <td style="width: 30%;">REVISION</td> <td style="width: 15%;">DATE</td> <td style="width: 10%;">SIGN</td> </tr> <tr> <td colspan="5" style="text-align: center;">REVISIONS</td> </tr> <tr> <td colspan="5" style="text-align: center;"> ARTIFICIAL LIMBS MANUFACTURING CORPORATION OF INDIA KANPUR </td> </tr> <tr> <td>DGN</td> <td></td> <td>NOM</td> <td colspan="2">KIT CONSISTING OF COMPONENTS FOR BEHIND THE EAR (BTE) HEARING AID - DIGITAL, CATEGORY-III ALONG WITH BATTERY & EAR TIPS</td> </tr> <tr> <td>DRN</td> <td></td> <td>MTL</td> <td colspan="2"></td> </tr> <tr> <td>CHD</td> <td></td> <td>TOL</td> <td colspan="2"> INTEGER ONLY ±0.500 mm ONE PLACE DECIMAL ±0.250 mm TWO PLACE DECIMAL ±0.125 mm UNLESS SPECIFIED </td> </tr> <tr> <td>DIM</td> <td>1/8" ±0.015"</td> <td>FIN</td> <td colspan="2"></td> </tr> <tr> <td>SCALE</td> <td>NTS</td> <td></td> <td colspan="2"></td> </tr> <tr> <td>APP</td> <td></td> <td>DRG No:-</td> <td>TD 0 E 17 0 Z0</td> <td>SHEET</td> </tr> <tr> <td></td> <td></td> <td>DATE</td> <td>09.07.2016</td> <td></td> </tr> </table>					SNo.	REGION	REVISION	DATE	SIGN	REVISIONS					ARTIFICIAL LIMBS MANUFACTURING CORPORATION OF INDIA KANPUR					DGN		NOM	KIT CONSISTING OF COMPONENTS FOR BEHIND THE EAR (BTE) HEARING AID - DIGITAL, CATEGORY-III ALONG WITH BATTERY & EAR TIPS		DRN		MTL			CHD		TOL	INTEGER ONLY ±0.500 mm ONE PLACE DECIMAL ±0.250 mm TWO PLACE DECIMAL ±0.125 mm UNLESS SPECIFIED		DIM	1/8" ±0.015"	FIN			SCALE	NTS				APP		DRG No:-	TD 0 E 17 0 Z0	SHEET			DATE	09.07.2016		
SNo.	REGION	REVISION	DATE	SIGN																																																				
REVISIONS																																																								
ARTIFICIAL LIMBS MANUFACTURING CORPORATION OF INDIA KANPUR																																																								
DGN		NOM	KIT CONSISTING OF COMPONENTS FOR BEHIND THE EAR (BTE) HEARING AID - DIGITAL, CATEGORY-III ALONG WITH BATTERY & EAR TIPS																																																					
DRN		MTL																																																						
CHD		TOL	INTEGER ONLY ±0.500 mm ONE PLACE DECIMAL ±0.250 mm TWO PLACE DECIMAL ±0.125 mm UNLESS SPECIFIED																																																					
DIM	1/8" ±0.015"	FIN																																																						
SCALE	NTS																																																							
APP		DRG No:-	TD 0 E 17 0 Z0	SHEET																																																				
		DATE	09.07.2016																																																					
	5	4																																																						

PRODUCT No.	B.O.No.	NOMENCLATURE	QTY.
TD 0 E 17 0 00	LH 72	COMPONENTS FOR BEHIND THE EAR (BTE) HEARING AID-DIGITAL, CATEGORY-III	01

SPECIFICATIONS :-COMPONENTS FOR BEHIND THE EAR (BTE) HEARING AID-DIGITAL, CATEGORY-III
 CONSISTING OF FOLLOWINGS:-

(i) Amplifier Assembly:-

Complete digital Amplifier assembled with SMD components, Tone control (N-H) & MPO Controls shall be provided either through trimmer or push button, Positive (+) & Negative (-) Battery Contacts plated with corrosion resistant material, Switch for microphone & Tele -Coil mode change, Automatic Gain Control Facility (AGC), masking/Insulation on both side of Amplifier assembly. Cleaned/unmasked soldering points for Receiver Assembly & Microphone Assembly.

Volume Control:- By switch or Rotary type potentiometer with min.4 stage numbering like 1,2,3 & 4 etc.

ON-OFF : on- Off switch to apply power either through switch or the battery compartment cover/door. The Amplifier Assembly shall operate on nominal 1.3V Zinc - Air Battery/NIMH rechargeable battery.

Electro - acoustic Characteristics :-

- (a) Max. OSPL 90 : 135dB
- (b) HF Average OSPL 90 : 125dB to 134dB
- (c) HF Average Full on gain (At 50dB input) : 60dB (min.)
- (d) Frequency Range : At least between 200Hz to 4000Hz
- (e) Total Harmonic Distortion : Should not exceed 7% at 1.3V Nominal Battery voltage measured at frequency 500,800 & 1600Hz at RTG position
- (f) Battery Current : ≤15 mA
- (g) equivalent input Noise Level : ≤30 dB SPL
- (h) Induction Coil Sensitivity (At 10 mA/m) : 95 dB (min.)
- (i) AGC Characteristics :
 - (i) Steady state input/output characteristics : With the measured and specified curves matched at the point corresponding to 70 dB input SPL, the measured curve at 50 & 90 dB input SPL from the curves specified by the manufacturer for the model by more than ±5 dB.
 - (ii) Dynamic output characteristics : The attack & release times shall be within ±5 milliseconds or ±50% whichever is larger, of the values specified by the manufacturer for the model.

(ii) Receiver Assembly:-

Receiver suitable for the BTE Hearing Aid - Digital, Receiver completely assembled with cushion & coupler, suitable length of Litz wires to be soldered to receiver points with colour coding for assembly with Amplifier Assembly. Receiver Acoustic Connection with or without Receiver Shield shall be suitable for assembly of receiver in Housing pair assembly of BTE Hearing Aid. Masking /Insulation shall be coated on soldering points & litz wires of Receiver Assembly. Other ends of Litz wires shall be unmasked/not insulated suitable to soldering on Amplifier Assembly. Receiver shall be able to work on nominal battery voltage 1.3 V.

(iii) Microphone Assembly:-

Microphone suitable for BTE Hearing Aid - Digital. Microphone completely assembled with Boot & nozzle. Suitable length of Litz wires to be soldered to Microphone points with colour coding for assembly with amplifier assembly OR Microphone with flat strip connector to be soldered to Microphone points for assembly with amplifier assembly. Masking/Insulation shall be coated on soldering points & Litz wires/flat strip connector of Microphone assembly. Other ends of Litz wires/flat strip connector shall be unmasked/not insulated suitable to soldering on Amplifier Assembly. Microphone shall be able to work on nominal battery voltage 1.3 V.

(iv) Housing Pair Assembly:-

Housing Pair with "ALIMCO" & "ISI" Mark printing as per fig.1 shown below. Trimmer door, Trimmer Label shall be printed as N-H & MPO and suitable indication of Trimmer position, Battery Door. Suitable Ear Hook For Housing pair assembly, plated with corrosion resistant material cross pan head tapping screws suitable for Housing pair assembly.

Housing Pair Assembly as per over all dimensions :-

- Length : 60mm Max.
- Width : 25mm Max.
- Thickness : 15mm Max.
- Material : ABS Gd.1
- Colour : Cinamon (Skin), Cream, Brown, Black
- Design : The housing should be so designed that the method of battery replacement does not require the use of tools, either to open/close the battery compartment or to replace the batteries.
- Mass : The mass of the kit of all the 4 components mentioned above taken together excluding the battery, ear Insert & adaptor shall not exceed 10gm excluding the ear Tip/mould

Serial Number to be printed on Battery Door /Housing as per ALIMCO advice

- (v) Shelf Life of Kit : 24 Months
- (vi) Test Report : May provide the Hearing Aid Analyser test report for the sample quoted.
- (vii) Packing Requirement : Items/Components shall be packed so as to avoid damage during transportation & handling.

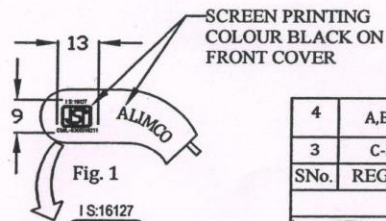

NOTE:-
 1. SAMPLE OF SCREEN PRINTING TO BE GOT APPROVED BEFORE SUPPLY.

4	A,B-10	SPECIFICATION OF RECEIVER & MICROPHONE ASSY MODIFIED	28.05.18	<i>[Signature]</i>
3	C-5	ISI MARK WITH CM/L No. ADDED	09.07.16	<i>[Signature]</i>
SNo.		REGION	REVISION	DATE SIGN
REVISIONS				
ARTIFICIAL LIMBS MANUFACTURING CORPORATION OF INDIA KANPUR				
DGN	<i>[Signature]</i>	NOM	COMPONENTS FOR BEHIND THE EAR (BTE) HEARING AID-DIGITAL, CATEGORY-III	
DRN	<i>[Signature]</i>	MTL	_____	
CHD	<i>[Signature]</i>	HEAT TREATMENT	_____	
DIM	IN mm	SURFACE TREATMENT	_____	
SCALE	NTS			
APP	<i>[Signature]</i>	B.O. No. LH 72	REV	SHEET 1 OF 1
DATE	18.02.2015	DRG No. TD 0 E 17 0 00	4	

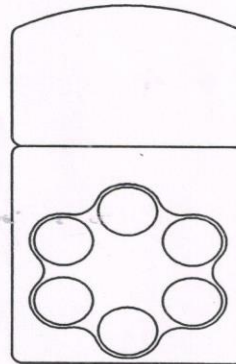
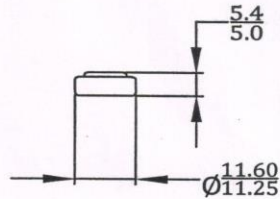

PACKING REQUIRMENT

MTL:- (EH 87)

675 ZINC AIR BATTERY

- NOMINAL VOLTAGE - 1.4V
- CAPACITY - 600mAh Approx
- BATTERY SIZE - 675 (PR 44)
- AVERAGE WEIGHT - 1.70gm Approx
- TERMINALS - FLAT
- SHELF LIFE - 03 YEARS MIN.

NOTE:-

1. ONE PACKET OF BATTERIES (A SEALED PACKET OF 6 NOS. BATTERIES) USED IN BTE DIGITAL TYPE HEARING AIDS.

3.	D - 5	SPECIFICATION OF EH 87 MODIFIED	28.05.18	<i>KL</i>
2.	---	DRAWING REDESIGN & REDRAWN	08.07.16	<i>SD/DD1</i>
SN _o .	REGION	REVISION	DATE	SIGN

REVISIONS



ARTIFICIAL LIMBS
MANUFACTURING CORPORATION
OF INDIA
KANPUR



DGN	<i>Asish</i>	NOM	675 ZINC AIR BATTERY	
DRN	<i>Asish</i>	MTL	INDICATED	
CHD	<i>gaur</i>	TOL	INTEGER ONLY ±0.500 mm ONE PLACE DECIMAL ±0.250 mm TWO PLACE DECIMAL ±0.126 mm UNLESS SPECIFIED	
DIM	IN mm	FIN		
SCALE	NTS			
APP	<i>sd/DD1</i>			
DATE	21.04.2009	DRG No:-	TD 0 E 11 0 00	REV 3 SHEET 10F1

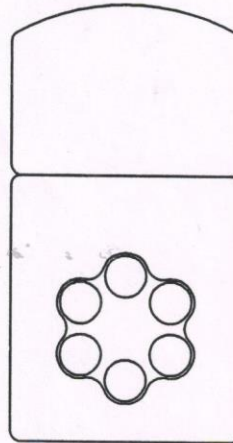
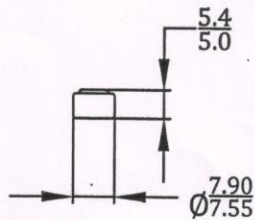

PACKING REQUIRMENT

MTL:- (EH 86)

13 ZINC AIR BATTERY

- NOMINAL VOLTAGE - 1.4V
- CAPACITY - 310mAh Approx
- BATTERY SIZE - 13 (PR 48)
- AVERAGE WEIGHT - 0.80gm Approx
- TERMINALS - FLAT
- SHELF LIFE - 03 YEARS MIN.

NOTE:-

1. ONE PACKET OF BATTERIES (A SEALED PACKET OF 6 NOS. BATTERIES) USED IN BTE DIGITAL TYPE HEARING AIDS.

3.	D - 5	SPECIFICATION OF EH 86 MODIFIED	28.05.18	<i>[Signature]</i>
2.	---	DRAWING REDESIGN & REDRAWN	08.07.16	<i>[Signature]</i>
SNNo.	REGION	REVISION	DATE	SIGN

R E V I S I O N S



ARTIFICIAL LIMBS
MANUFACTURING CORPORATION
OF INDIA
KANPUR



DGN	<i>[Signature]</i>	NOM	13 ZINC AIR BATTERY	
DRN	<i>[Signature]</i>	MTL	INDICATED	
CHD	<i>[Signature]</i>	TOL	INTEGER ONLY	±0.500 mm
DIM	IN mm		ONE PLACE DECIMAL	±0.250 mm
			TWO PLACE DECIMAL	±0.126 mm
SCALE	NTS	FIN	UNLESS SPECIFIED	

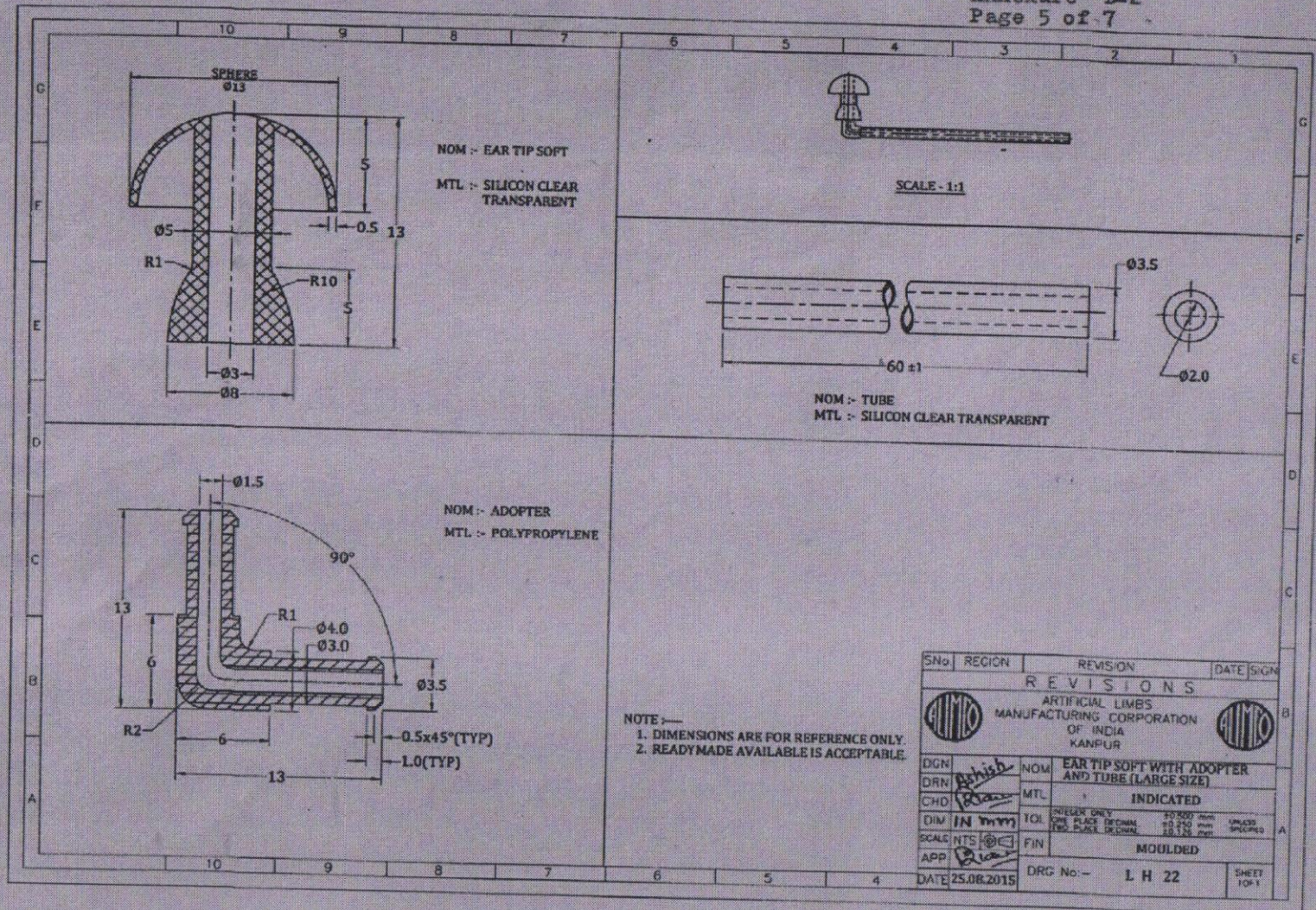

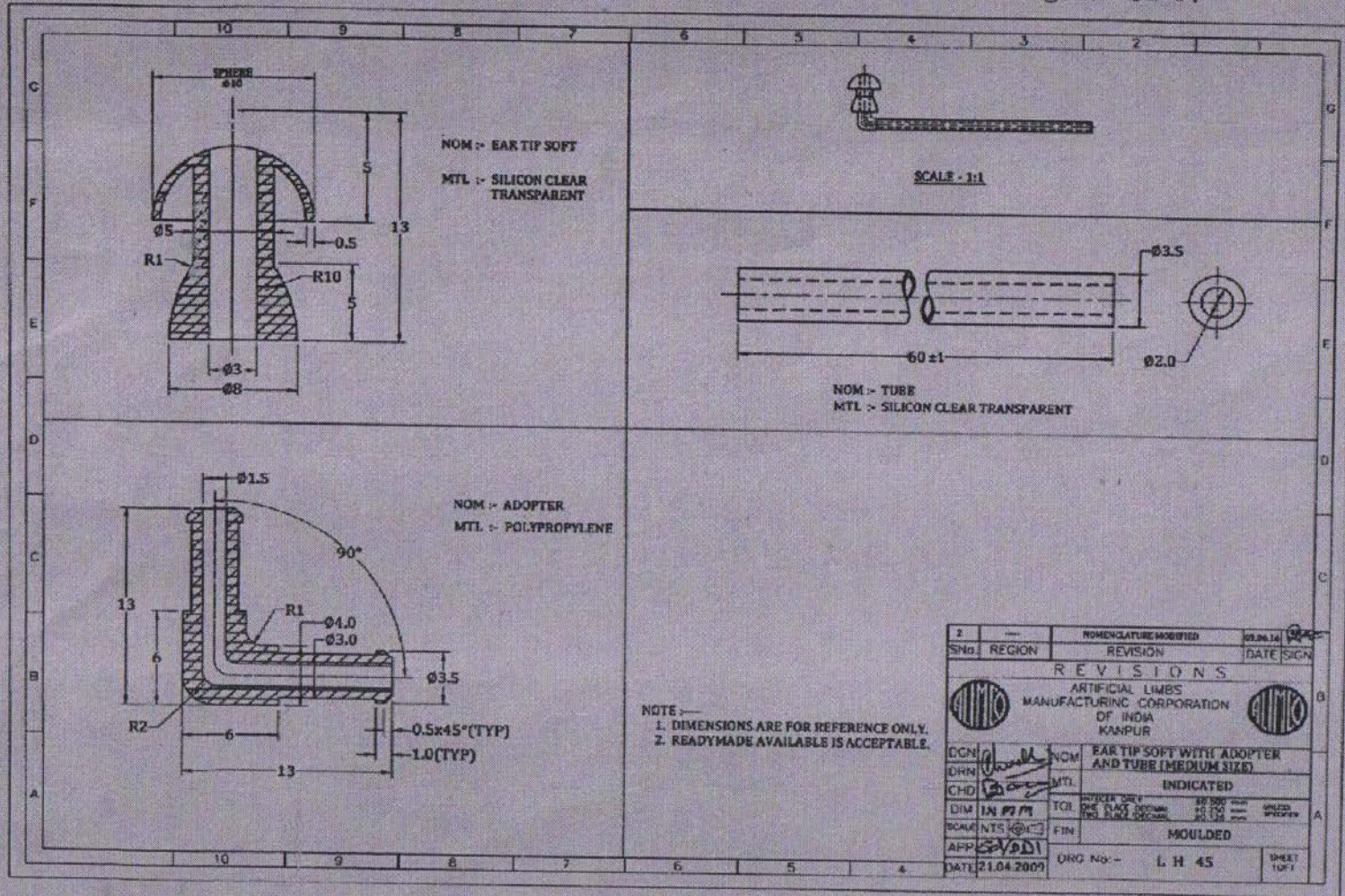

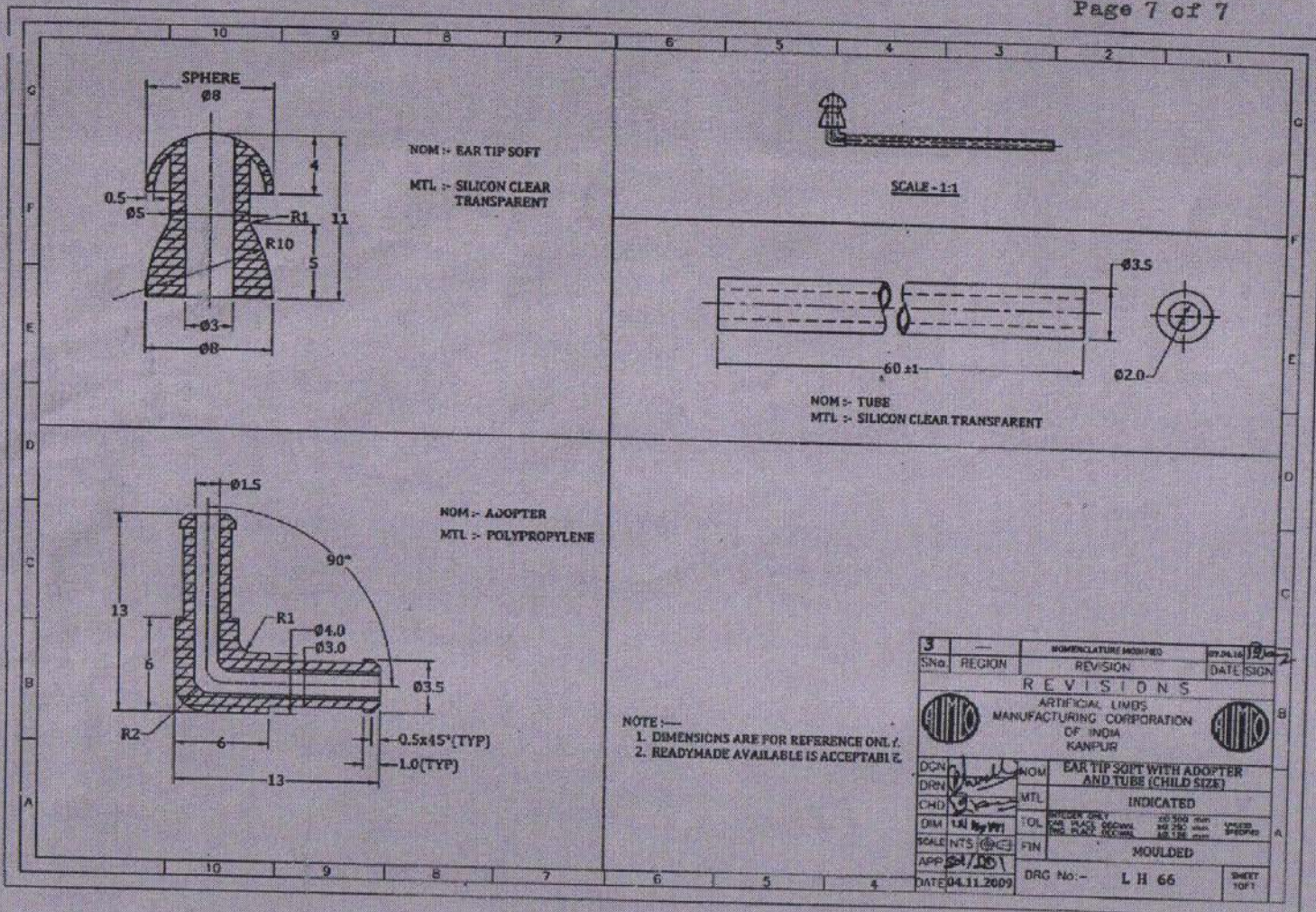

3	—	NOMENCLATURE MODIFIED	07.06.10	12
SNo.	REGION	REVISION	DATE SIGN	
REVISIONS				
ARTIFICIAL LIMBS MANUFACTURING CORPORATION OF INDIA KANPUR				
DCN	DRN	CHD	DIM	SCALE
1/1	1/1	1/1	1/1	1/1
NOM		INDICATED		
MTL		MOULDED		
FIN		MOULDED		
APP		DATE		
04/11/2009		DRG No:- L H 66		SHEET 10/11

To,

Sub: Acceptance of Terms & Conditions of Tender.

Name of Tender / Work: - _____

Tender Reference No: _____

Dear Sir,

1. I / We have downloaded / obtained the tender document(s) for the above mentioned 'Tender/Work' from the web site(s) namely:
As per your advertisement, given in the above mentioned website(s).
2. I / We hereby certify that I / we have read the entire terms and conditions of the tender documents from Page No. _____ To _____
(Including all documents like annexure(s), schedule(s), etc...), which form part of the contract agreement and I / we shall abide hereby by
the terms / conditions / clauses contained therein.
3. The corrigendum(s) issued from time to time by your department/ organization too have also been taken into consideration, while
Submitting this acceptance letter.
4. I / We hereby unconditionally accept the tender conditions of above mentioned tender document(s) / corrigendum(s) in its totality /
Entirety.
5. I / We do hereby declare that our Firm has not been blacklisted/ debarred/ terminated/ banned by any Govt. Department/Public sector
undertaking.
6. I / We certify that all information furnished by our Firm is true & correct and in the event that the information is found to be
incorrect/untrue or found violated, then your department/ organization shall without giving any notice or reason therefore or summarily
reject the bid or terminate the contract, without prejudice to any other rights or remedy including the forfeiture of the full said earnest
money deposit absolutely.

Yours Faithfully,

(Signature of the Bidder, with Official Seal)